



Industrial-type socket-outlets conforming to IEC 309 Standard, with mechanical interlock consisting of a circuit breaker enabling the plug to be connected and disconnected only in the open position, and the switch to close only with the plug inserted. Wide range including models with rotary switch and fuseholder base, AUTOMATIKA with 6kA C characteristic miniature circuit breaker, and version with safety transformer. High application versatility thanks to the possibility of assembly in back-mounting and flush-mounting boxes, and boards of the 68 Q-DIN and Q-MC ranges.

Colour	Red	Rated current (A)	32
IP degree	IP67	No. of poles	3P+E
Shock resistance	IK08	Reference h	6
Type	Vertical	Rated voltage	380 - 415 V
Frequency	50/60 Hz	Protection	MCB
With back-mounting box	Yes	Operating temperature	-25 + +40°C
Circuit breaker	MT 6 kA C characteristic	Electrocod	2222
Glow wire test	850 °C (IB socket) - 650 °C (bottom)	Thermo-pressure with ball	-

#### BEHAVIOUR WITH CHEMICAL AND ATMOSPHERIC AGENTS

Saline solution	Acids		Bases		Solvents				Mineral oil	UV rays
	Concentrated	Diluted	Concentrated	Diluted	Hexane	Benzol	Acetone	Alcohol		
Resistant	Not resistant	Limited resistance	Limited resistance	Limited resistance	Limited resistance	Not resistant	Not resistant	Limited resistance	Limited resistance	Resistant

#### DIMENSIONAL

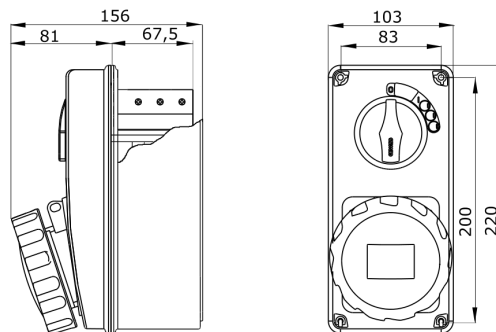

#### TECHNICAL SYMBOLOGY



IP67



IK08

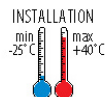

INSTALLATION

min -25°C max +40°C



850 °C (IB socket) -  
650 °C (bottom)

#### STANDARDS/APPROVALS

