

Accessories and complementary items for distribution and automation boards range 46.

For boards LxH (mm)	310x425	Suitable for	46QP - 46QM - 46QX
Type	Full	Type of material	Steel
Electrocod	0303		

DIMENSIONAL

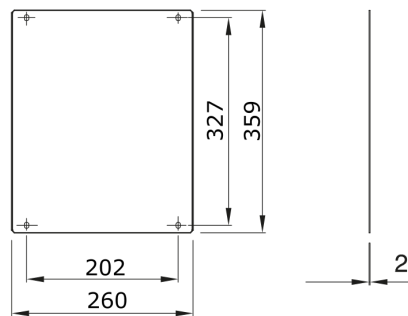

TECHNICAL SYMBOLOGY STANDARDS/APPROVALS



<p>GEWISS S.p.A. Via A. Volta, 1 24069 Cenate Sotto - Bergamo - Italy tel. +39 035 94 61 11 fax +39 035 94 69 09</p>	<p>www.gewiss.com sat@gewiss.com Last update 26/04/2018</p>	<p>Data, measures, designs and pictures are shown only as informativ purposes, and could be changed without previous notice</p>
--	---	---