

For boards LxH (mm)	236x316	For boards	44 CEP
Type of material	Galvanized metal	Electrocod	1320

DIMENSIONAL

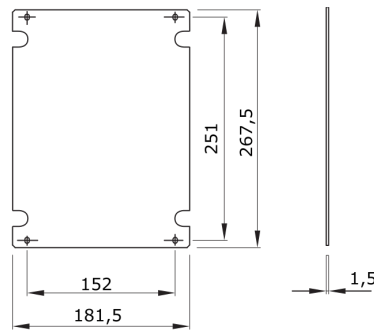

TECHNICAL SYMBOLOGY STANDARDS/APPROVALS

<p>GEWISS S.p.A. Via A. Volta, 1 24069 Cenate Sotto - Bergamo - Italy tel. +39 035 94 61 11 fax +39 035 94 69 09</p>	<p>www.gewiss.com sat@gewiss.com Last update 19/04/2018</p>	<p>Data, measures, designs and pictures are shown only as informativ purposes, and could be changed without previous notice</p>
--	---	---