

Part number

CHI 16 LS



Bulkhead mounting housing, C-TYPE series, with 1 lever, size "77.27", with metal cover

Product description

Product type	Bulkhead mounting housing
Series	C-TYPE
Closing type	With 1 lever
Size	Size 77.27
Cable entry	Without cable entry
Specification	With metal cover

Technical data

IP degree of protection	IP65
Further technical details	
Weight	190,08 g
Operating temperature range (min, max)	-40°C...+125°C

Material properties

Other materials	Lever: Stainless steel, polyamide (PA) Gasket: NBR
Colour	RAL 7040 grey
RoHs conformity	Compliant
China RoHs - EFUP	E
REACH SVHC substances	No

Approvals / Standards

Certifications	CQC, DNV, BV
UL	ECBT2
cUL	ECBT8

General ordering information

EAN13 code	8015747017992
eCl@ss 8.1	27440202
ETIM 7.0	EC000437

Packaging Information

Packaging length	475,00 mm
Packaging height	220,00 mm
Packaging width	200,00 mm
Packaging weight	4,38 kg
Packaging volume	20,90 dm ³
Packaging description	Carton box
Packaging quantity	20 Pcs
Packaging EAN code	8015747018005
Sub-packaging weight	1,10 kg
Sub-packaging description	Plastic packaging
Sub-packaging quantity	5 Pcs
Sub-packaging EAN barcode	8015747018012

Part number

CHI 16 LS



Catalogue drawings

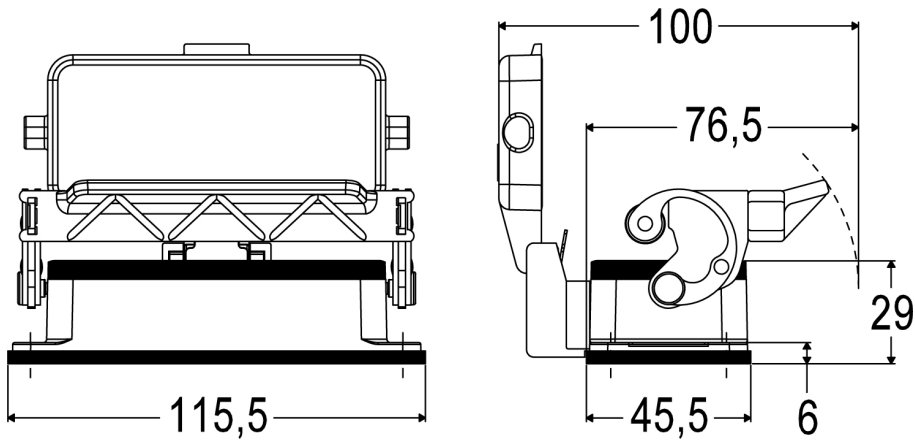

Notes

Dimensions shown in mm are not binding and may be changed without notice.
