

BI8-M18-2APS8X2-H1141

Inductive Safety Sensor

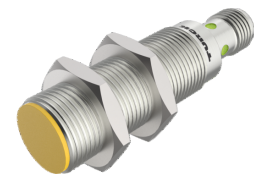
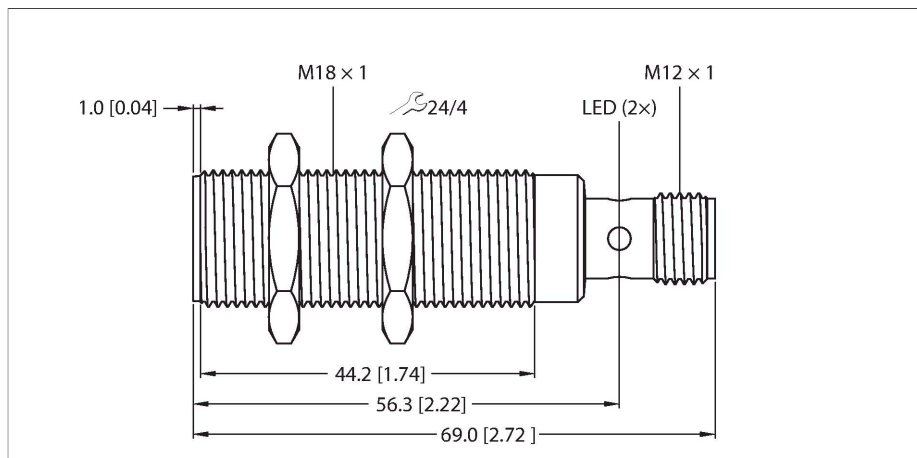

Technical data

Type	BI8-M18-2APS8X2-H1141
ID	100016607
General data	
Rated switching distance	8 mm
Secured switch-on distance	6.5 mm
Secured switch-off distance	12 mm
Mounting conditions	Flush
Correction factors	St37 = 1; Al = 0.45; stainless steel = 0.8; Ms = 0.4
Repeat accuracy	≤ 2 % of full scale
Temperature drift	≤ ±10 %
Hysteresis	3...15 %
Electrical data	
Operating voltage U_B	19.2...28.8 VDC
Ripple U_{ss}	≤ 10 % U_{Bmax}
No-load current	≤ 20 mA
Impulse withstand voltage	1.5 kV
Isolation test voltage	0.0288 kV
Short-circuit protection	yes
Wire break/reverse polarity protection	Complete
Output function	4-wire, 2 x OSSD, NO contact, PNP
Number of safe semiconductor outputs	2
Switching frequency	0.1 kHz
Mechanical data	
Design	Threaded barrel, M18 x 1
Dimensions	69 mm
Housing material	Metal, CuZn

Features

- M18 × 1 threaded barrel
- Nickel-plated brass
- SIL 2 (IEC 61508)
- PL d (ISO 13849-1)
- 2 x OSSD output, NO contact, PNP
- DC 4-wire, 24 VDC

Wiring diagram

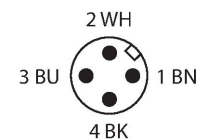
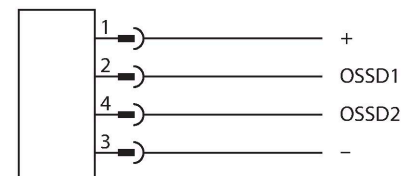

Functional principle

Inductive sensors detect metal objects contactless and wear-free. For this, they use a high-frequency electromagnetic AC field that interacts with the target. Inductive sensors generate this field via an RLC circuit with a ferrite coil.

Technical data

Active area material	Plastic, PA
Max. tightening torque of housing nut	12 Nm
Electrical connection	Connector, M12 × 1
Environmental conditions	
Ambient temperature	-25...+70 °C
Vibration resistance	55 Hz (1 mm)
Shock resistance	30 g (11 ms)
Protection class	IP67
Safety Data	
PL acc. to EN ISO 13849-1	Level d
Category acc. to DIN EN 13849-1:2008	2
SIL acc. to IEC 61508	2
Power-on indication	LED, Red
Switching state	LED, Green

Mounting instructions

Mounting instructions/Description



Distance D	54 mm
Distance W	3 x Sn
Distance T	3 x B
Distance S	1.5 x B
Distance G	64 mm
Diameter active area B	Ø 18 mm

Accessories

BST-18B

6947214

Mounting clamp for threaded barrel sensors, with dead-stop; material: PA6

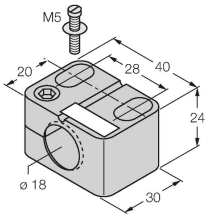

QM-18

6945102

Quick-mount bracket with dead-stop; material: Chrome-plated brass. Male thread M24 × 1.5. Note: The switching distance of the proximity switches may change when using quick-mount brackets.

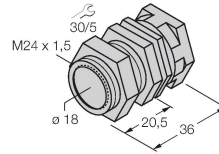

MW18

6945004

Mounting bracket for threaded barrel sensors; material: Stainless steel A2 1.4301 (AISI 304)

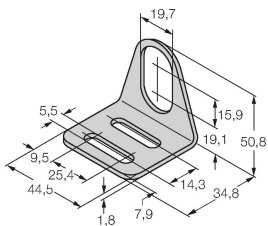

BSS-18

6901320

Mounting clamp for smooth and threaded barrel sensors; material: Polypropylene

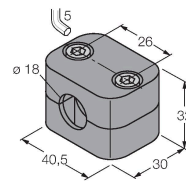

Accessories

Dimension drawing

Type

ID

RKC4.4T-2/TEL

6625013

Connection cable, M12 female connector, straight, 4-pin, cable length: 2 m, jacket material: PVC, black; cULus approval

