

MODULAR DEVICES FOR RESIDUAL CURRENT PROTECTION

RCBO - MDC

Technical data

TYPE		MDC 45		MDC 60		MDC 100		MDC 100 MA				
Standard		IEC EN 61009-1 IEC EN 61009-2-1		IEC EN 61009-1 IEC EN 61009-2-1		IEC EN 61009-1 IEC EN 61009-2-1		IEC EN 61009-1 IEC EN 61009-2-1				
Rated current (In)	(A)	6-32		6-32		6-32		6-32				
Utilization category		A		A		A		A				
Rated operational voltage (Ue)	(V AC)	230/400 - 240/415		230/400 - 240/415		230 - 240		110				
Insulation voltage (Ui)	(V)	500		500		500		500				
Rated frequency	(kHz)	50/60		50/60		50/60		50/60				
Rated impulse withstand voltage (Uimp)		4		4		4		4				
Overvoltage category		III		III		III		III				
Number of poles		1+N, 2	3, 4	1+N, 2	3, 4	2, 3		2				
Energy limiting class		3	1	3	1	3		3				
Breaking capacity												
Alternating current	IEC/EN 61009-1	Icn	(A)	4500		6000		10000		10000		
		Ics	(A)	1 Icn		1 Icn		0.75 Icn		0.75 Icn		
	IEC/EN 60947-2	Icu	230/240 V	(kA)	6	-	10	-	15	-	15	-
		Ics	400/415 V	(kA)	-	4,5	-	6	-	-	-	-
Rated residual operating current (IΔn)		(mA)		100% Icu		75% Icu		100% Icu		50% Icu		
Type	AC	A	F	30		30		30		30		
				300		300		300		-		
				30		30		30		30		
				-		-		100		-		
				300		300		300		-		
				-		-		30		-		
-		-		300		-		-				
-		-		30		30		-				
-		-		30		30		-				
Level of immunity (8/20 μs)		(A)		250		250 (for AC and A types) 3000 (for A[IR], A[S] and F types)		250 (for AC and A types) 3000 (for A[IR] and F types)		250		
Residual making and breaking capacity (IΔm)		(A)		4500		4500		4500		4500		
Voltage independent working				yes		yes		yes		yes		
Wiring	cable section (mm²)	rigid		≤ 1x35 - ≤ 2x16 - ≤ 1x16+2x10		≤ 1x35 - ≤ 2x16 - ≤ 1x16+2x10		≤ 1x35 - ≤ 2x16 - ≤ 1x16+2x10		≤ 1x35 - ≤ 2x16 - ≤ 1x16+2x10		
		flexible		≤ 1x35 - ≤ 2x16 - ≤ 1x16+2x10		≤ 1x35 - ≤ 2x16 - ≤ 1x16+2x10		≤ 1x35 - ≤ 2x16 - ≤ 1x16+2x10		≤ 1x35 - ≤ 2x16 - ≤ 1x16+2x10		
Electrical endurance		10000		10000		10000		10000		10000		
Mechanical endurance		20000		20000		20000		20000		20000		
Max. no. of usable modular accessories		2		2		2		2		2		
Upline/Downline power supply		yes		yes		yes		yes		yes		
Status displayed		yes		yes		yes		yes		yes		
Mounting position		any		any		any		any		any		
Rated tightening torque	(Nm)	2		2		2		2		2		
Screwdriver suggested		PZ2		PZ2		PZ2		PZ2		PZ2		
Degree of protection	terminals	IP20		IP20		IP20		IP20		IP20		
	front	IP40		IP40		IP40		IP40		IP40		
Pollution degree		2		2		2		2		2		
Tropicalization		55°C - RH 95%		55°C - RH 95%		55°C - RH 95%		55°C - RH 95%		55°C - RH 95%		
Reference temperature	(°C)	30		30		30		30		30		
Operating temperature	(°C)	-25 +60 ⁽¹⁾		-25 +60 ⁽¹⁾		-25 +60 ⁽¹⁾		-25 +60 ⁽¹⁾		-25 +60 ⁽¹⁾		
Storage temperature	(°C)	-40 +70		-40 +70		-40 +70		-40 +70		-40 +70		
Double connection (cable+fork busbar)		yes (only downstream)		yes (only downstream)		yes (only downstream)		yes (only downstream)		yes (only downstream)		
Weight per pole	(g)	120		120		120		120		120		
Tripping characteristic		C		C	B	C	B	C		C		
Rated currents available (In)	(A)	6		6		6		6		6		
		10		10		10		10		10		
		13		13		13		13		13		
		16		16		16		16		16		
		20		20		20		20		20		
		25		25		25		25		25		
32		32		32		32		32		32		

⁽¹⁾ With temperatures greater than 30°C, derating of In rated current is expected

MODULAR DEVICES FOR RESIDUAL CURRENT PROTECTION

ADD-ON RCD - BD AND BDHP

Technical data

TYPE		BD		BDHP	BDHP ADJUSTABLE
Standard		IEC EN 61009-1 app. G IEC EN 61009-2-1		IEC EN 61009-1 app. G IEC EN 61009-2-1	IEC EN 60947-2 app. B
Rated current (I _n)	(A)	≤ 25	≤ 63	≤ 125	≤ 125
Rated operational voltage (U _e)	(V AC)	230/400		230/400	400
Insulation voltage (U _i)	(V)	500		500	500
Rated frequency	(Hz)	50/60		50/60	50
Rated impulse withstand voltage (U _{imp})	(kV)	4		4	4
Overvoltage category		III		III	III
Number of poles		2,3,4		2,3,4	4
Rated residual operating current (I _{Δn})	(mA)				
Type	AC	10 ⁽¹⁾	-	-	-
		30	30	30	-
		300	300	300	-
		500	500	-	-
	A	30	30	30	-
		300	300	300	-
	A[IR]	-	30	-	-
	A[S]	-	300	300	-
		-	1000	1000	-
	A[Adj.]	-	-	-	300 - 500 - 1000 - 3000
Adjustable tripping time (t)	(ms)	-		-	0 - 60 - 150
Level of immunity (8/20 μs)	(A)	250 (for AC and A types) 3000 (for A[IR] and A[S] types)		250 (for AC and A types) 3000 (for A[S] type)	3000
Residual making and breaking capacity (I _{Δm})	(A)	I _{cn} circuit breaker		I _{cn} circuit breaker	I _{cn} circuit breaker
Voltage independent working		yes		yes	yes
Wiring	cable section (mm ²)	rigid	≤ 1x35 - ≤ 2x16 - ≤ 1x16+2x10	≤ 1x70 - ≤ 2x25 - ≤ 2x25+1x10	≤ 1x70 - ≤ 2x25 - ≤ 2x25+1x10
		flexible	≤ 1x35 - ≤ 2x16 - ≤ 1x16+2x10	≤ 1x50 - ≤ 2x25 - ≤ 3x16	≤ 1x50 - ≤ 2x25 - ≤ 3x16
Upline/Downline power supply		yes		yes	yes
Mounting position		any		any	any
Rated tightening torque	(Nm)	2		3,5 / 3 (terminals)	3,5 / 3 (terminals)
Screwdriver suggested		PZ2		PZ2	PZ2
Degree of protection	terminals	IP20		IP20	IP20
	front	IP40		IP40	IP40
Pollution degree		2		2	2
Tropicalization		55°C - RH 95%		55°C - RH 95%	55°C - RH 95%
Reference temperature	(°C)	30		30	30
Operating temperature	(°C)	-25 +40		-25 +40	-25 +40
Storage temperature	(°C)	-40 +70		-40 +70	-40 +70
Weight per pole	(g)	100		200	200

⁽¹⁾ Only for 2P versions

MODULAR DEVICES FOR RESIDUAL CURRENT PROTECTION

RCCB - IDP

Technical data

TYPE		IDP NA	IDP	IDP 4P (3M)	SD K	IDP 125A	
Standard		IEC EN 61008-1 IEC EN 61008-2-1	IEC EN 61008-1 IEC EN 61008-2-1 IEC EN 62423 (type F and B)	IEC EN 61008-1 IEC EN 61008-2-1	IEC EN 61008-1 IEC EN 61008-2-1	IEC EN 61008-1 IEC EN 61008-2-1	
Rated current (In)	(A)	25-40-63	25-80	25-40	80-100	125	
Rated operational voltage (Ue)	(V a.c.)	230/400 - 240/415	230/400 - 240/415	400	400 - 415	400	
Insulation voltage (Ui)	(V)	500	500	500	400	500	
Rated impulse withstand voltage (Uimp)	(kV)	4	4	4	4	4	
Overvoltage category		III	III	III	III	III	
Rated frequency	(Hz)	50	50/60	50/60	50	50	
Poles		2 (Up to 40A) 4 (Up to 63A)	2, 4	4	4	4	
Number of modules		2 (2P) 4 (4P)	2 (2P) 4 (4P) 4 (2P/4P type B)	3	4	4	
Rated residual operating current (IΔn)	(mA)						
Type	AC	-	10 ⁽¹⁾	-	-	-	
		30	30	30	30	30	
		-	100	100	-	-	
		300	300	300	300	300	
		-	500	500	-	500	
		-	10 ⁽¹⁾	-	-	-	
	A	30	30	30	30	30	
		-	100	100	-	-	
		300	300	300	300	300	
		-	500	500	-	500	
		IR - Impulse resistant	-	30	-	30	-
		S - Selective	-	300	-	300	-
F	-	500	-	-	-		
B	-	30	-	-	-		
-	-	30	-	-	-		
-	-	300	-	-	-		
Level of immunity (B/20μs)	(A)	250	250 (Type AC - A) 3000 (Type A[IR] - A[S] - F - B)	250	250 (Type AC - A) 3000 (Type A[IR] - A[S])	250	
Residual making and breaking capacity (I _{dm})	(A)	10 x In (630A min)	10 x In (630A min)	630	800 (80A) - 1000 (100A)	1250	
Making and breaking capacity (I _m)	(A)	10 x In (630A min)	10 x In (630A min)	630	800 (80A) - 1000 (100A)	1250	
Voltage independent working		yes	yes	yes	yes	yes	
Wiring	Cable section						
	rigid	≤ 1x35 - ≤ 2x16 - ≤ 1x16+2x10	≤ 1x35 - ≤ 2x16 - ≤ 1x16+2x10	≤ 1x35 - ≤ 2x16 - ≤ 1x16+2x10	≤ 1x35 - ≤ 2x16 - ≤ 1x16+2x10	≤ 35	
	flexible	≤ 1x35 - ≤ 2x16 - ≤ 1x16+2x10	≤ 1x35 - ≤ 2x16 - ≤ 1x16+2x10	≤ 1x25 - ≤ 1x16+1x10 - ≤ 3x6	≤ 35	≤ 50	
Electrical endurance		5000	10000	5000	4000	10000	
Mechanical endurance		10000	20000	10000	10000	10000	
Upstream / Downstream supply		yes	yes	yes	yes	yes	
Mounting position		any	any	any	any	any	
Rated tightening torque	(Nm)	2	3	2	2	3	
Screw type		PZ2	PZ2	PZ2	PZ2	PZ2	
Pollution degree		2	2	2	2	2	
Fire resistance			Glow wire Test IEC 60695-2-11 according with IEC 61008-1				
IP degree (inside the distribution board)		IP40	IP40	IP40	IP40	IP40	
Tropicalization		55°C - RH 95%	55°C - RH 95%	55°C - RH 95%	55°C - RH 95%	55°C - RH 95%	
Installation altitude	(m)	≤ 2000	≤ 2000	≤ 2000	≤ 2000	≤ 2000	
Operating temperature (average daily temperature ≤ 35°C)	(°C)	-5 ÷ +40	-25 ÷ +60 ⁽²⁾	-25 ÷ +40	-25 ÷ +40	-25 ÷ +60 ⁽²⁾	
Storage temperature	(°C)	-40 ÷ +70	-40 ÷ +70	-40 ÷ +70	-35 ÷ +60	-40 ÷ +70	
Double connection (cable + fork busbar)		no (for 2P) yes (only downstream for 4P)	yes (Upstream and downstream)	yes (Upstream and downstream)	yes (Upstream and downstream)	no	
Signalization of the relay tripping		no	yes 175 (2P), 320 (4P)	no	no	no	
Weight of device	(g)	160 (2P), 300 (4P)	275 (2P TYPE B) 340 (4P TYPE B)	280	350	555	

⁽¹⁾ Up to 25A

⁽²⁾ With temperatures greater than 40°C, derating of In rated current is expected

RATED CONDITIONAL RESIDUAL SHORT-CIRCUIT CURRENT IΔc (kA)

Rated current In	25A / 40A (NA)		25A / 40A			63A(NA)	63A	80A	100A	125A
	2P	4P	2P	4P	4P (3M)	2P/4P	2P/4P	2P	4P	4P
Fuse	gG 63A	6	6	10	10	6	10*	-	-	-
	gG 80A	-	-	-	-	-	10	6	10	-
	gG 100	-	-	-	-	-	-	-	-	10
	gG 125	-	-	-	-	-	-	-	-	-
MCB	MTC 45	-	-	4,5	-	-	-	-	-	-
	MTC 60	-	-	6	-	-	-	-	-	-
	MTC 100	-	-	10	-	-	-	-	-	-
	MT 45	-	-	4,5	-	-	-	-	-	-
	MT 60	-	-	6	-	-	6	-	-	-
	MT 100	-	-	10	-	-	10	-	-	-
	MT 250	-	-	10	-	-	10	-	-	-
	MTHP 160	-	-	-	-	-	10	10	10	10
MTHP 250	-	-	10	-	-	10	-	-	-	

* Only F and B type RCCBs

MDC 45 - 60 - 100 compact residual current circuit breakers with overcurrent protection**Technical characteristics**

For circuit overcurrent protection and the residual current protection of devices and services, there are the MDC 45, MDC 60 and MDC 100 compact residual current circuit breakers with overcurrent protection.

The MDC compact miniature circuit breakers with residual current release have a thermomagnetic part with the same characteristics as the MTC circuit breakers. The residual current release - assembled in the factory inside the same modular shell - is available in AC, A, A[IR] impulse resistant, A[S] selective and F versions with a rated residual current of 30, 100 and 300 mA.

Some advice about selection and installation

Due to their design, RCCBs are sensitive devices and therefore more exposed to phenomena that can cause an untimely trip (the RCCB trips without a real fault). The untimely trips are usually caused by atmospheric perturbations, such as electric discharges generated by lightening, operations performed on the electric distribution network, disturbances generated by industrial equipments and the presence of electronic filters in the electric circuit (also inside of common household appliances) that create permanent leakage currents towards earth.

The problems caused by an untimely trip of a residual current circuit breaker can range, in a domestic environment, from a limited inconvenience due to having to reset the RCCB, to more considerable economic damage due to the loss of the content of a freezer.

In the industrial and tertiary sectors, where the systems are extended and the service continuity must be more guaranteed, the amount of damage is certainly larger; it is sufficient to think of application areas such as photovoltaics, telecommunications, Electronic Data Processing, public lighting or monitoring systems in order to understand how the continuity of electrical services plays a fundamental role for economic return on investment, productivity and public safety.

A possible measure that can be taken to prevent the inappropriate tripping of the circuit breakers would be to install GEWISS **reinforced immunity RCCBs**, which are identified with the letters **IR** and characterised by greater resistance against the causes of the untimely trips, in comparison to standard versions.

More specifically, the **IR RCCBs** are able to:

- not trip in the case of atmospheric as well as operational overvoltages because the level of immunity against the impulsive residual current with normalised form 8/20 μ s reaches the value of 3000A (for standard versions, the peak values arrives up to 250A);
- not trip in the case of temporary earth leakages that occur when turning on electronic devices equipped with filters present in the power supplies of the most common equipments, such as PCs, decoders, variable speed electronic household appliances (air conditioners, washing machines, etc.), power supplies for lamps and dimmers.

In addition to the characteristics of type IR, **type F** guarantees also protection against indirect contacts due to variable-frequency earth faults which are generated in the presence of a single-phase frequency converter, or inverter, i.e. a device used in domestic and industrial appliances, such as washing machines, vacuum cleaners, dishwashers, ventilation systems, pumps, etc ... to regulate the speed of an electric motor, acting on the voltage and frequency of the power supply. Inverter technology is increasingly widespread in modern equipment because it allows to reduce energy consumption by improving the performance of electric motors.

Unlike the IR type, the **selective RCCB** has a delayed tripping action that cannot be adjusted because it is set according to the Standard CEI EN 61008 and 61009 that supply the table shown hereunder where it is clear the relationship between the fault current and the tripping time. Thanks to the S type RCCB, in case of a leakage fault, it is possible to minimise the parts of the system that are out of service by creating a vertical selectivity between the low sensitivity circuit breaker installed upstream and circuit breakers with higher sensitivity connected downstream (see the above illustration).

Type	In [A]	I Δ [A]	Standard values of break time (s) at a residual current (I Δ)			
			1xI Δ	2xI Δ	5xI Δ	500 A
General	Any value	Any value	0,3	0,15	0,04	0,04
S (Selective)	Any value	> 0,030	0,13-0,5	0,06-0,2	0,05-0,15	0,04-0,15

In detail, the S type provides total or chronometric selectivity between two devices installed in series. Thanks to the intrinsic delay of the S type, the tripping time of the instantaneous residual current circuit breaker located downstream is always less than the delay time of the S type, which guarantees the perfect coordination between the two devices.

MODULAR DEVICES FOR RESIDUAL CURRENT PROTECTION

MDC temperature performance

In (A)	Temperature					
	10°C	20°C	30°C	40°C	50°C	60°C
6	7.2	6.6	6	5.7	5.3	5
10	11.8	10.8	10	9.6	9.1	8.6
13	14.8	14	13	12.2	11.2	10.3
16	18.2	17.2	16	15.2	14.3	13.4
20	22.8	21.4	20	19.5	18.9	18.4
25	28.5	26.8	25	24	23	22
32	36.5	34.2	32	30.8	29.5	28.2

MDC power loss per pole

In (A)	6		10		13		16		20		25		32	
	Pole	N	Pole	N	Pole	N	Pole	N	Pole	N	Pole	N	Pole	N
R (mΩ)	29.4	2.6	20.6	2.6	14.5	2.6	8.9	2.6	6.8	2.6	4.6	2.6	3.6	2.6
P (W)	1.06	0.09	2.06	0.26	2.45	0.44	2.28	0.67	2.72	1.04	2.88	2	3.67	2.66

BD - BDHP add-on for miniature circuit breaker

Add-on for MT (BD) and MTHP (BDHP) miniature circuit breakers, which can be coupled by the installer once only (in compliance with Standard CEI EN 61009, appendix G). AC, A, A[IR] impulse resistant, A[S] selective and adjustable types are available.

BD and BDHP power loss per pole

Power loss (W)		Rated current of the associated MT/MTHP miniature circuit breaker [A]																
		1	2	3	4	6	10	13	16	20	25	32	40	50	63	80	100	125
BD add-on	2P	0.01	0.04	0.01	0.02	0.04	0.11	0.2	0.29	0.45	0.70	0.45	0.70	1.10	1.75	-	-	-
	3P-4P	0.002	0.008	0.02	0.03	0.07	0.21	0.37	0.53	0.83	1.30	0.65	1.00	1.60	2.50	-	-	-
BDHP add-on		-	-	-	-	-	-	-	-	0.2	0.3	0.5	0.8	1.25	2	1.4	2.2	3.4

MODULAR DEVICES FOR RESIDUAL CURRENT PROTECTION

IDP residual current circuit breakers

Technical characteristics

Two-pole and four-pole residual current circuit breakers without built-in overcurrent releases - free release monobloc.

AC type devices with instantaneous tripping are available (for residual sinusoidal alternating currents only), whereas A type residual current circuit breakers (suitable for residual one-way pulsating currents) are available in instantaneous, impulse-resistant and selective versions.

The range also includes RCCBs type F with the same immunity level of IR type (Impulse Resistant) for the protection of variable-frequency earth faults.

Moreover RCCBs type B with the same immunity level of IR type are available for the protection of electrical loads which can create earth fault currents with a direct component.

IDP temperature performance

In (A)	Temperature			
	30°C	40°C	50°C	60°C
25	25	25	22,5	20
40	40	40	36	32
63	63	63	56,7	50,4
80	80	80	-	-
100	100	100	-	-
125	125	125	120	110

Power loss per device (W)

Poles	No. of modules	Rated current In (A)					
		25	40	63	80	100	125
Type AC, A, A[IR], A[S] and F							
2	2	2,9	7,8	8,1	12,9	-	-
4	3	2,4	5,9	-	-	-	-
	4	4,4	11,7	12,2	21,6	23,4	26,7
Type B							
2	4	1	2,6	6,2	-	-	-
4	4	1,4	3,8	9,1	-	-	-

Composition rules for the modular residual current circuit breakers

In order to obtain a residual current circuit breaker from a miniature circuit breaker, it is necessary to observe these rules:

- 1 - there is no residual current device that can be associated with the MTC circuit breakers. There is the MDC compact monobloc residual current circuit breaker with overcurrent protection.
- 2 - the BD add-on residual current device can only be associated with the MT circuit breakers.
- 3 - the BDHP add-on residual current device can only be associated with the MTHP circuit breakers.

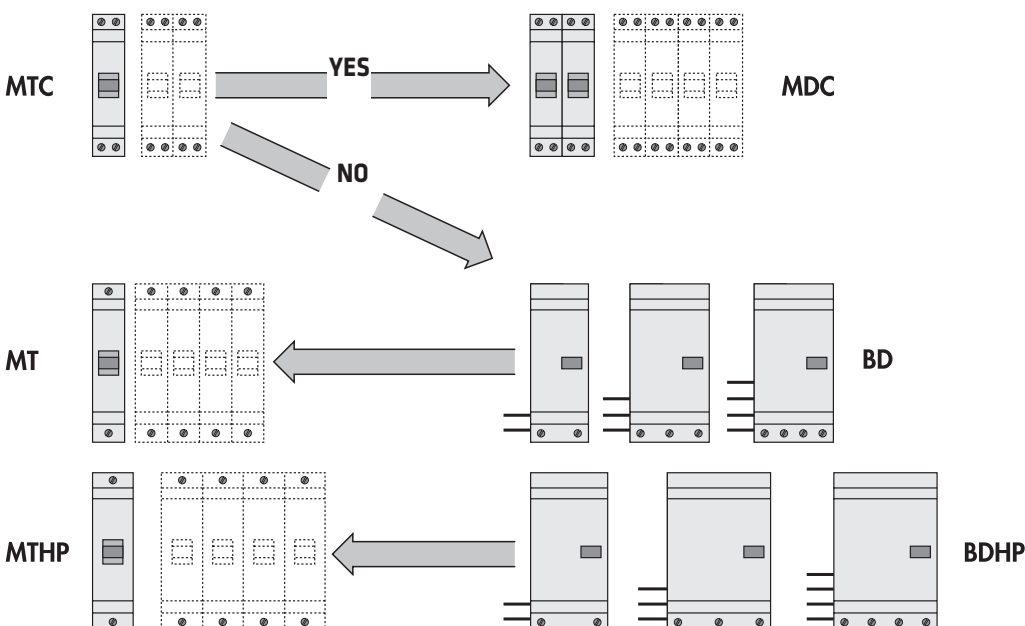

Tripping characteristics

Thermo-magnetic release

MDC 45 - 60 - 100 Characteristic C

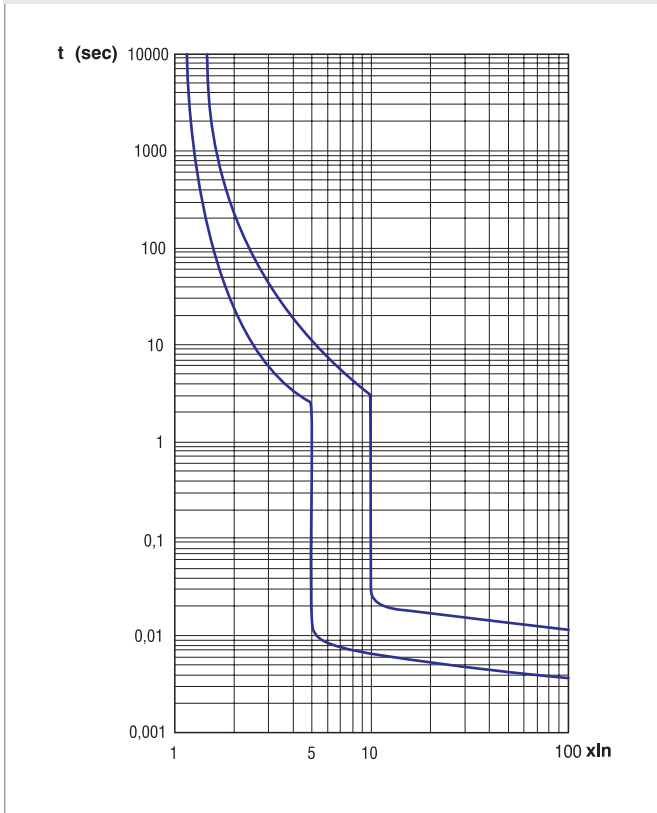

MDC 60 - 100 Characteristic B

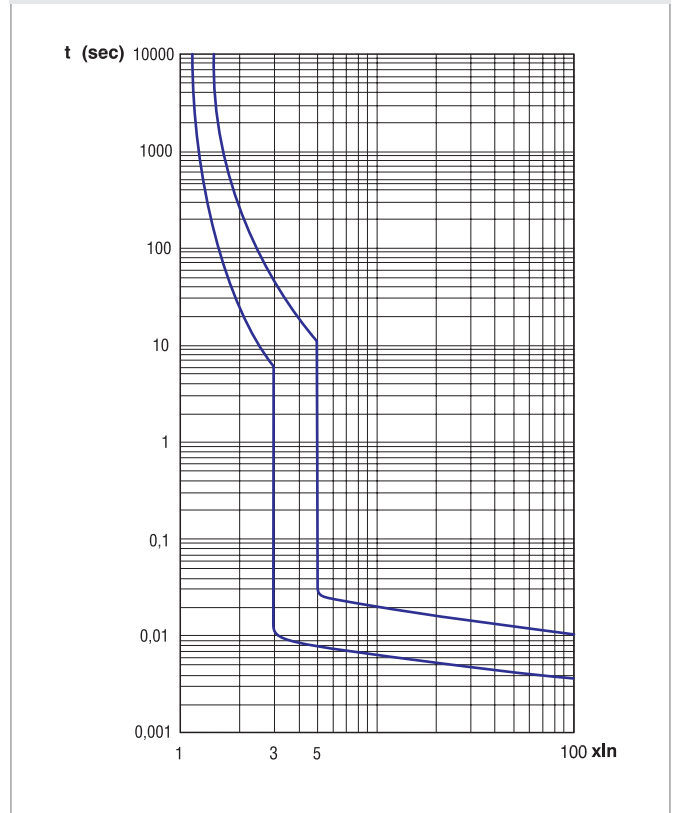

Peak current limitation characteristics

MDC - 1P+N, 2P - 230V version

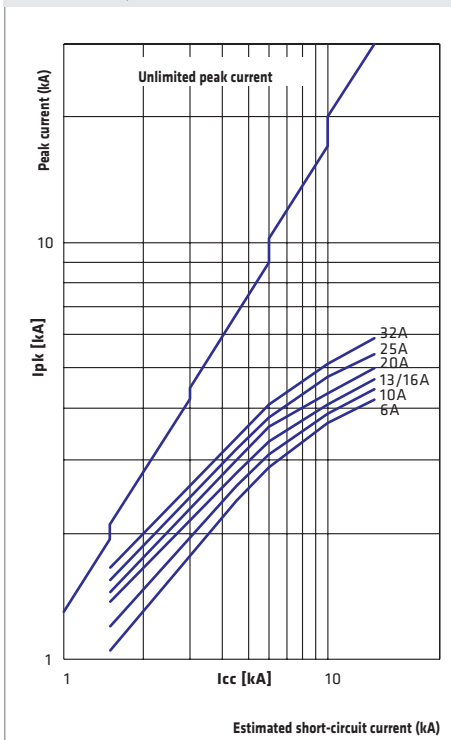

MDC - 3P, 4P - 400V version

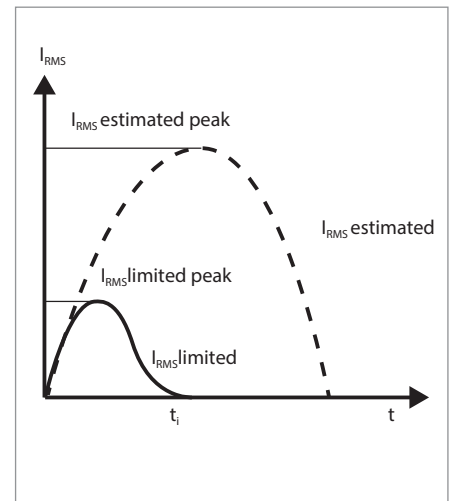
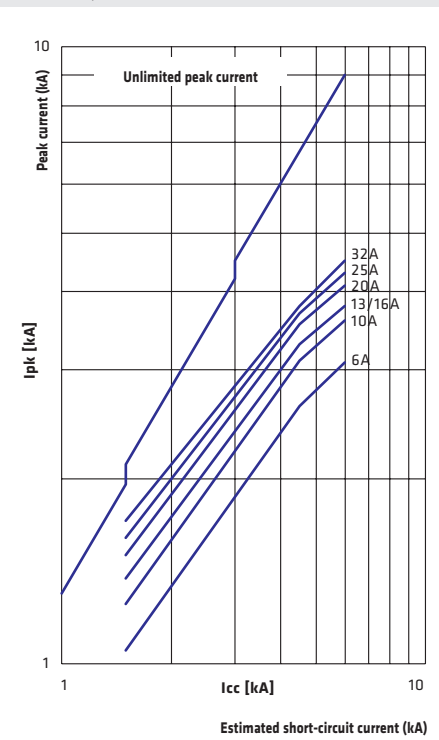

The following curves give the values of the peak current in relation to the estimated short-circuit current expressed in kA. Every curve refers to each rated current value of circuit breaker.

Specific let-through energy characteristics

MDC 45 - 1P+N, 2P - 230V versions

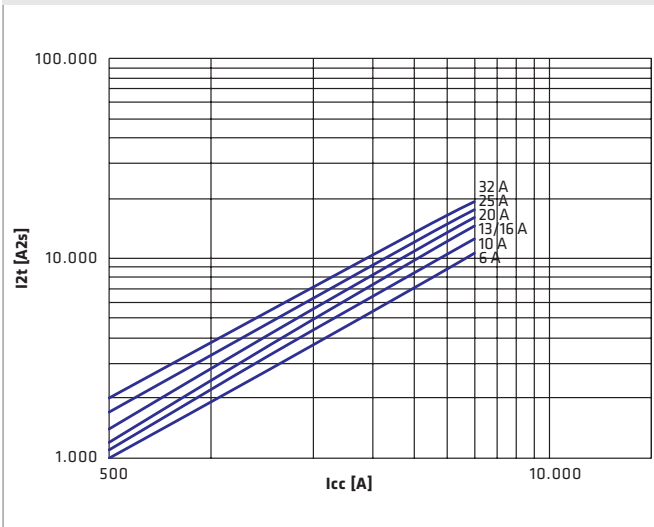

MDC 45 - 3P, 4P - 230/400V versions

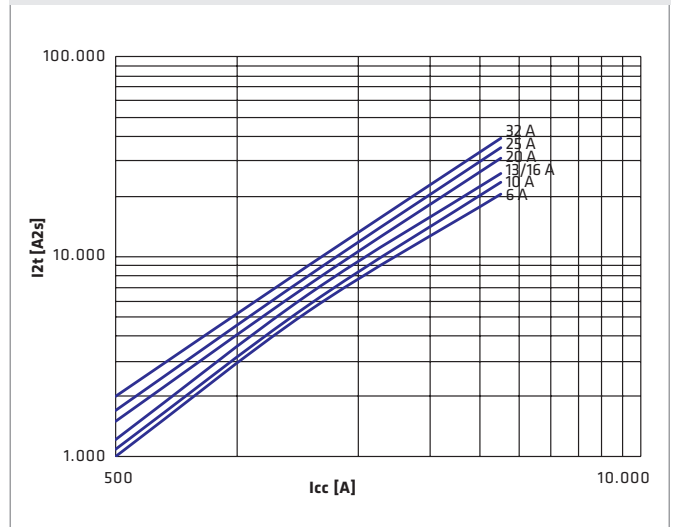

MDC 60 - 1P+N, 2P - 230V versions

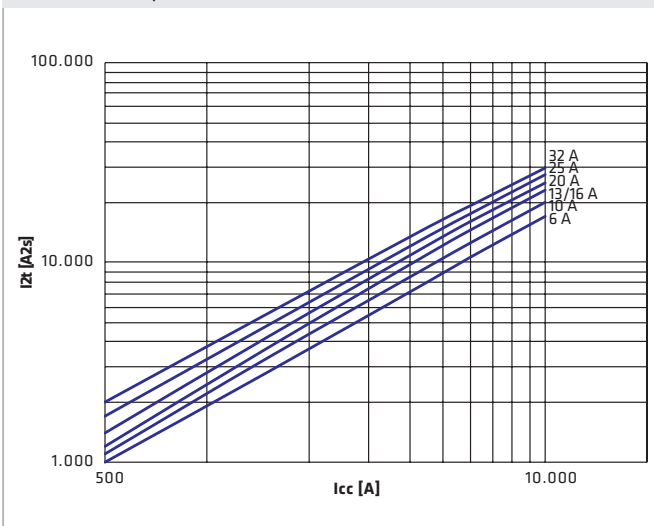

MDC 60 - 3P, 4P - 230/400V versions

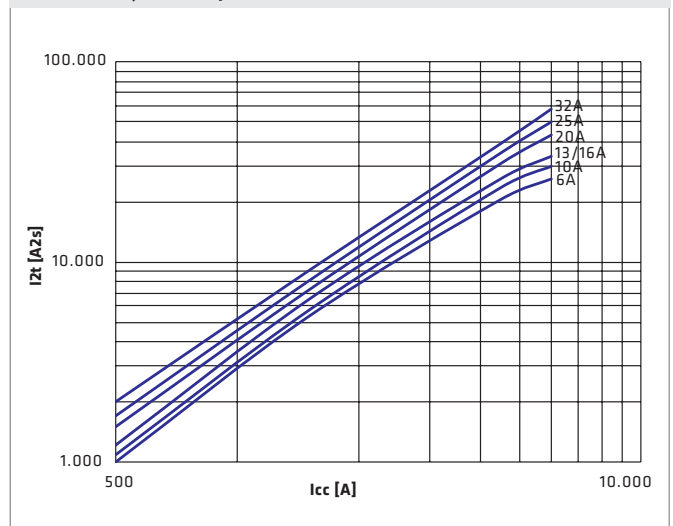

MDC 100 - 1P+N, 2P - 230V versions

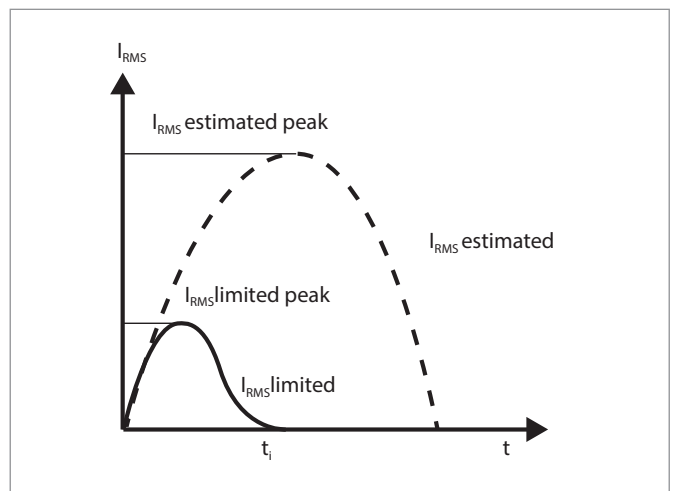
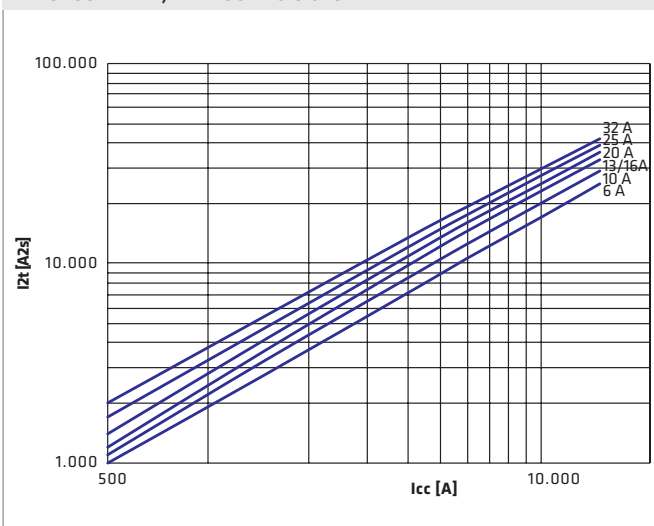

The curves above give the values of the specific let-through energy in relation to the short-circuit current expressed in A. Every curve refers to each rated current value of circuit breaker.

MODULAR DEVICES FOR RESIDUAL CURRENT PROTECTION

Residual current circuit breaker tripping characteristics

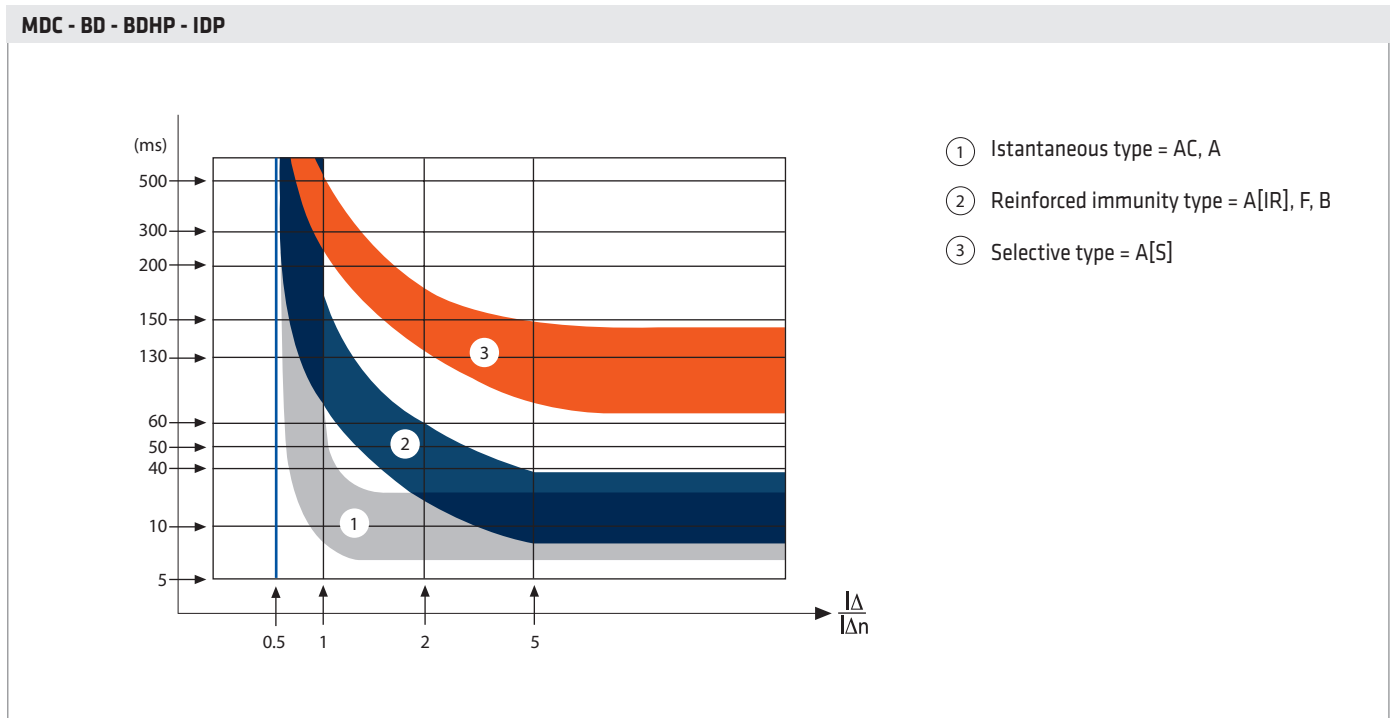



RCD TYPE	AC	A	F	B	Level of immunity (8/20μs)
RESIDUAL FAULT CURRENT TYPE	 • Sinusoidal alternating	 • Sinusoidal alternating • Pulsating	 • Sinusoidal alternating • Pulsating • Variable frequency	 • Alternating sinusoidal • Pulsating • Variable frequency • Smooth DC	
1. INSTANTANEOUS First level of residual current protection against direct and indirect contacts	✓	✓			250A
2. REINFORCED IMMUNITY Prevention of untimely interventions due to: • overvoltages due to indirect lightning strikes (8/20 μs impulse current waveform up to 3000A) • overvoltages due to manoeuvres on electrical network • overvoltages due to earth fault on three-phase system • permanent harmonics due electronic devices (immunity to currents with frequency higher than 50Hz) • starting current (immunity to the ring wave waveform)		✓	✓	✓	3000A
3. SELECTIVE Second level of residual-current protection for total or chronometric selectivity with downstream RCDs		✓			3000A

MODULAR DEVICES FOR RESIDUAL CURRENT PROTECTION

LOCAL RCCB

Technical data

TYPE	SAFETY SOCKET WITH RCCB		SAFETY SOCKET WITH RCCB (WATER PROTECTED)		RCCB SAFETY UNIT		
							
Standard	IEC EN 61008-1 IEC EN 61008-2-1 IEC 60884-1		IEC EN 61008-1 IEC EN 61008-2-1 IEC 60884-1		IEC EN 61008-1 IEC EN 61008-2-1		
Degree of protection	IP21		IP44		IP41		
Type of installation	flush-mounting		flush-mounting or surface-mounting (when installed inside the box GW95928)		flush-mounting		
Codes	GW95921	GW95922	GW95923	GW95924	GW95925	GW95926	
Rated residual operating current (I Δ n)	(mA)	10	30	10	30	10	30
Rated current (I $_n$)	(A)	16					
Rated operational voltage (U $_e$)	(V a.c.)	230 - 240					
Rated impulse withstand voltage (U $_{imp}$)	(kV)	4					
Overtoltage category		III					
Rated frequency	(Hz)	50					
Poles		1P+N					
RCCB type		A					
Level of immunity (8/20 μ s)	(A)	250					
Residual making and breaking capacity (I $_{dm}$)	(A)	500					
Making and breaking capacity (I $_m$)	(A)	500					
Rated conditional residual short-circuit current (I Δ c)	(A)	3000 (fuse gG 20A)					
Voltage independent working		yes					
Wiring	cable section (mm 2)	rigid		flexible		min 1.5 - max 2.5	
Electrical endurance		6000					
Mechanical endurance		10000					
Type of terminal		Screwless					
Pollution degree		2					
Tropicalization		55°C - RH 95%					
Operating temperature	(°C)	-25 ÷ + 40					
Storage temperature	(°C)	-40 ÷ + 70					
Weight	(g)	175		165		150	

Dimension tables

SAFETY SOCKET WITH RCCB	RCCB SAFETY UNIT

MODULAR DEVICES FOR RESIDUAL CURRENT PROTECTION

Dimension tables

MDC 45 - MDC 60 - MDC 100 RESIDUAL CURRENT CIRCUIT BREAKERS WITH OVERCURRENT PROTECTION

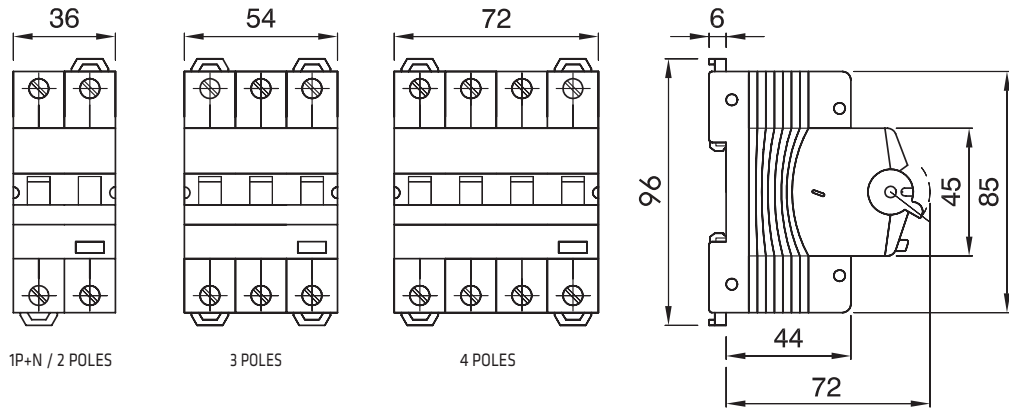

BD - ADD-ON RESIDUAL CURRENT DEVICES

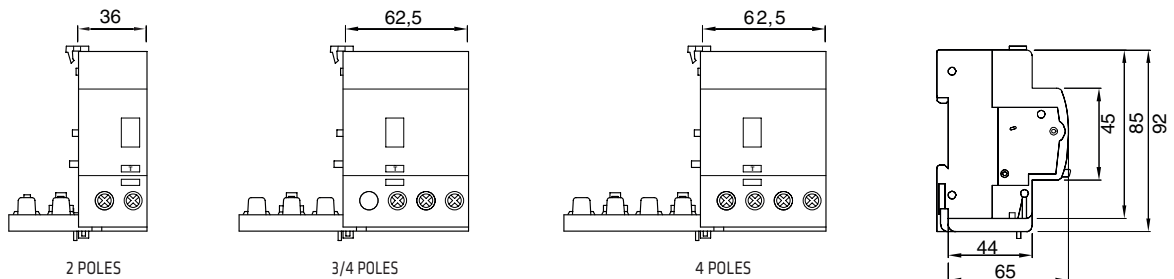

BDHP - ADD-ON RESIDUAL CURRENT DEVICES

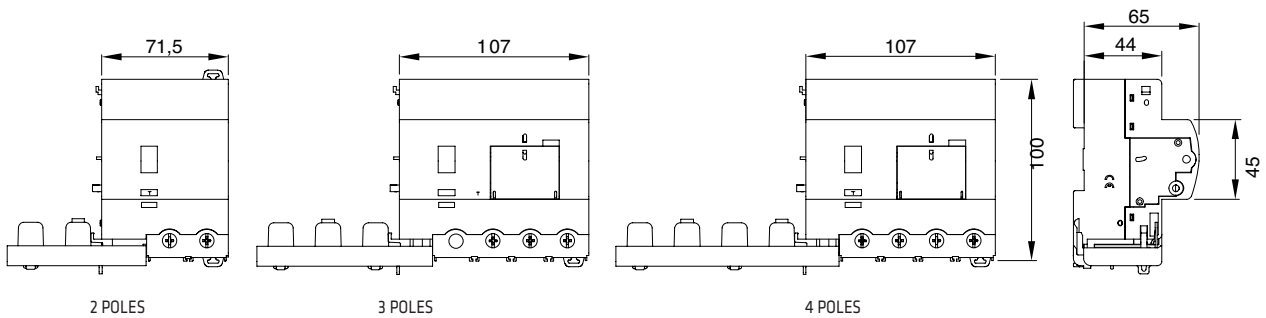

MODULAR DEVICES FOR RESIDUAL CURRENT PROTECTION

IDP - 2P AND 4P (4M) RESIDUAL CURRENT CIRCUIT BREAKERS

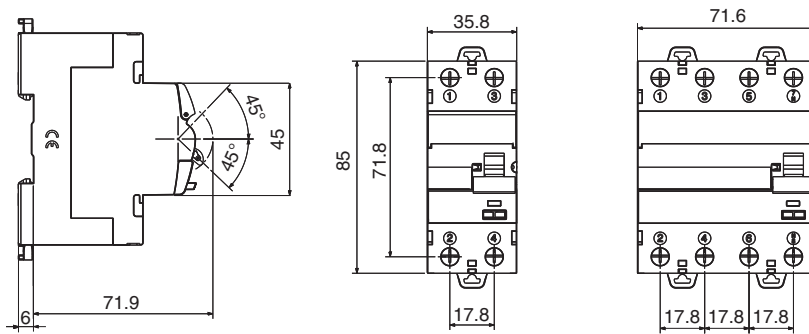

IDP - 4P (3M) RESIDUAL CURRENT CIRCUIT BREAKERS

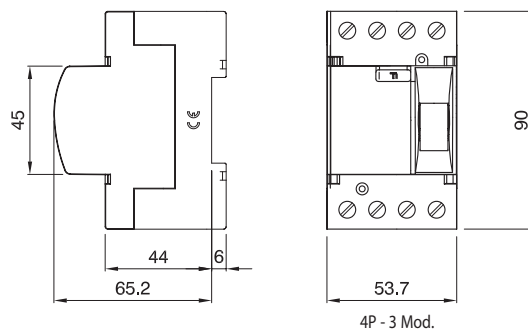

SD K - 4P 80A AND 100A RESIDUAL CURRENT CIRCUIT BREAKERS

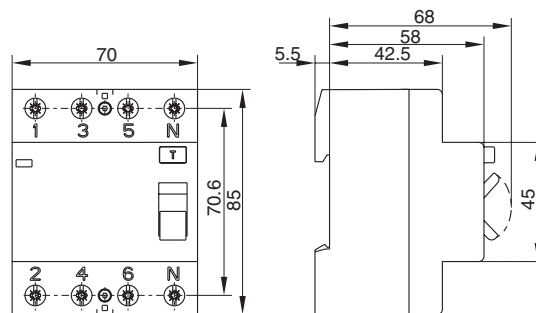

IDP - 125A RESIDUAL CURRENT CIRCUIT BREAKERS

