

70 RT HP is a new range of 16A to 160A switch disconnectors in isolating material and metal, supplied in a box. Available in control and emergency versions, the range is completed by board versions for front-panel or DIN rail assembly, in 16 to 63A options, all of which can be equipped with auxiliary contacts. These devices have been designed to deliver the ultimate in reliability, functionality and performance. They offer a technologically advanced solution that simplifies installation, reduces wiring times and ensures maximum safety and robustness, even in the most demanding conditions, thanks to the use of high-performance materials.

Version		Box	Material	Metal
Type		For emergency	Rated current (A)	40
No. of poles		3P+N	Circuit breaker	Rotary isolator
IP degree		IP66	Mechanical resistance	IK10 (IK08 knob)
Ambient temperature		-25 +60 °C	Lid screws (no. and type)	4 metal screws
Holes entry		2 x M20 + 2 x M25	Lockable	YES (max. 3 locks in OFF)
Type of accessory		Max. 2 auxiliary contacts	Current in AC22 (415V)	40
Current in AC23 (415V)		40	Cable section	Max 10 mm <sup>2</sup>
Outer dim. LxHxD (mm)		140x165x64	Electrocod	1742

#### BEHAVIOUR WITH CHEMICAL AND ATMOSPHERIC AGENTS

Saline solution	Acids		Bases		Solvents				Mineral oil	UV rays
	Concentrated	Diluted	Concentrated	Diluted	Hexane	Benzol	Acetone	Ethyl alcohol		
Resistant	Limited resistance	Resistant	Not resistant	Limited resistance	Limited resistance	Not resistant	Not resistant	Limited resistance	Resistant	Resistant

#### DIMENSIONAL

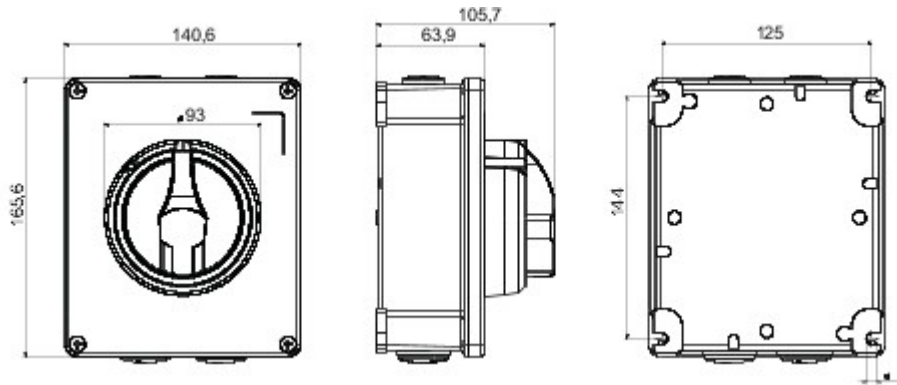

#### TECHNICAL SYMBOLOGY

**IP**

IP66

**IK**

IK10 (IK08 knob)

#### STANDARDS/APPROVALS

