

PKG3M-10/TXL

Actuator and Sensor Cable, PUR – Connection Cable

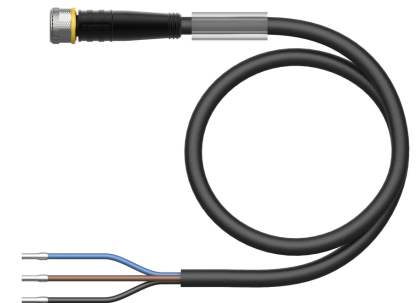
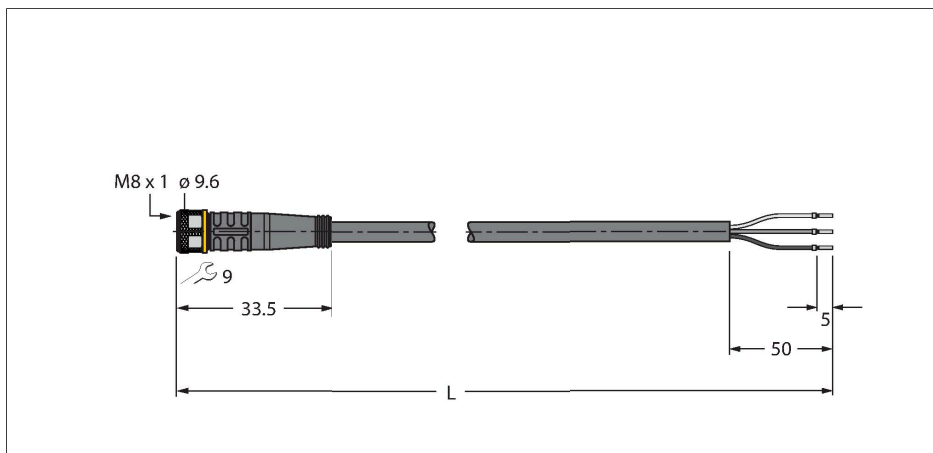

Technical data

Type	PKG3M-10/TXL
ID no.	6625552
Connector A	Female, M8 × 1, Straight
Number of Pins	3
Contacts	Brass, CuZn, Gold-plated
Contact carriers	Plastic, TPU, Black
Connector body	Plastic, TPU, Black
Coupling nut/screw	Brass, CuZn, Nickel-plated
Seal	Plastic, FPM/FKM
Tightening torque (range)	0.5 ... 0.6 Nm (observe max. torque of mating connector!)
Mechanical lifespan	> 100 Mating cycles
Pollution degree	3
Type of protection	IP67, IP69K, Only in screwed condition
Cable	
Cable diameter	Ø 4.3 mm ± 0.20
Cable length	10 m
Cable jacket	PUR, Black
Core insulation	PP
Core cross-section	3 x 0.34 mm ²
Arrangement of strands	42 x 0.1 mm
Core colors	BN, BU, BK
Electrical properties at +20 °C	
Rated voltage	50 V _{AC} /60 V _{DC}
Test voltage	2000 V
Current	4 A
Insulation resistance	> 30.5 MΩ/km

Features



- Female M8, straight, 3-pin
- Jacket material: PUR
- Jacket color: black
- Suitable for drag chain use
- Resistant to chemicals, UV radiation and oils
- Flame-retardant (FT2 in accordance with UL 1581, IEC 60332-2-2)
- Free from halogen, silicone, PVC and LABS
- Particularly resistant to abrasion
- Approval: cULus
- RoHS-compliant
- Protection class: IP67, IP69K
- Cable length: 10 m

Cable Cross-Section

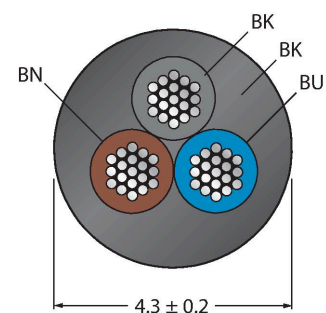

Technical data

forward resistance	max. 57 Ω/km
Mechanical and chemical properties	
Bending radius (stationary installation)	≥ 5 x Ø
Bending radius (flexible use)	≥ 10 x Ø
Bending cycles	≥ 5 million
Admissible acceleration	max. 5 m/s ²
Admissible travel path, horizontal	5 m (at 5 m/s ²)
Admissible travel path, vertical	2 m (at 5 m/s ²)
Admissible traversing speed	3.3 m/s
Torsional stress	± 180 °/m
Ambient temperature range (stationary)	-50 °C...+80 °C
Ambient temperature range (In motion)	-25 °C...+80 °C
Drag chain operation	-25 °C...+60 °C

Contact assignment

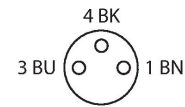

Circuit Diagram



Accessories

TORQUE-WRENCH-SET-AS

6936170



Torque wrench set; handles with adjustable torque 0.4-1.0 Nm, torque wrench for M8 (SW9), fork wrench for M12 (SW 14)

BLANK-LABEL-FOR-CORDSETS-TEL-TXL

6936206

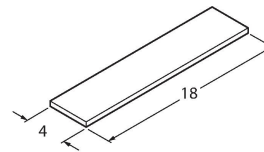

Label for TEL and TXL cables, length: 18 mm, height: 4 mm, material: polycarbonate (PC), color: white, halogen-free and flame-retardant

HAS5131-0

6905402

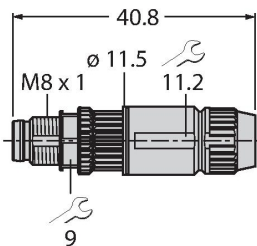

Field-wireable male connector, M8 x 1, straight, 3-pin, insulation piercing connection, cable feedthrough 2.5 to 5.1 mm, core cross-section/terminal capacity 0.14 to 0.34 mm², plastic housing, metal nut

BS5133-0

6901012

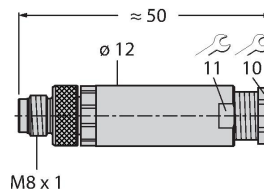

Konfektionierbarer Stecker, M8 x 1, gerade, 3-polig, Schraubklemmanschluss, Leitungsdurchlass 3.5 bis 5.0 mm, Adernquerschnitt/ Klemmvermögen 0.14 bis 0.50 mm², Kunststoffgehäuse, Metallüberwurfschraube

HS5131-0

6902710

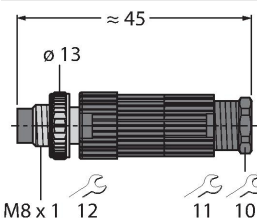

Field-wireable male connector, M8 x 1, straight, 3-pin, pressfit technology, cable feedthrough 4.0 to 5.0 mm, core cross-section/terminal capacity 0.14 to 0.34 mm², plastic housing, metal nut

HS5231-0

6902810

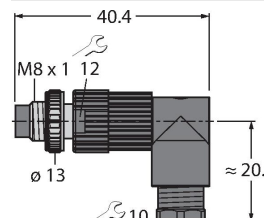

Field-wireable male connector, M8 x 1, angled, 3-pin, pressfit technology, cable feedthrough 4.0 to 5.0 mm, core cross-section/terminal capacity 0.14 to 0.34 mm², plastic housing, metal nut

FW-PRKPM0320-SA-S-0406

100002292

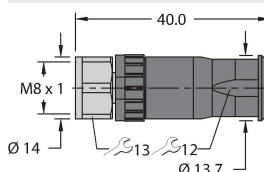

Field-wireable female connector, M8 x 1, straight, 3-pin, screw terminal connection, cable feedthrough 4.0 to 5.5 mm, core cross-section/terminal capacity 0.14 to 0.5 mm², plastic housing, metal coupling nut