

A

B

C

D

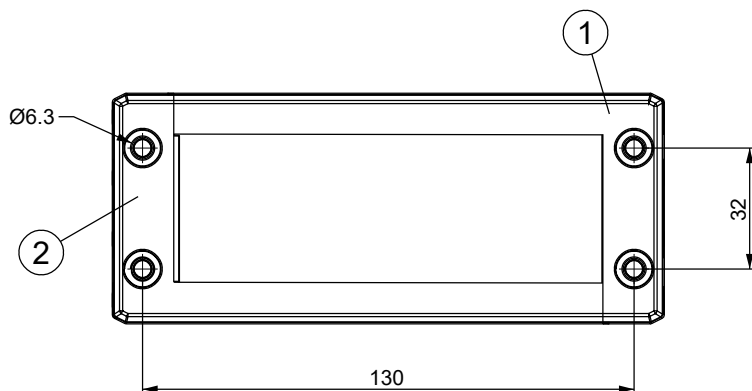
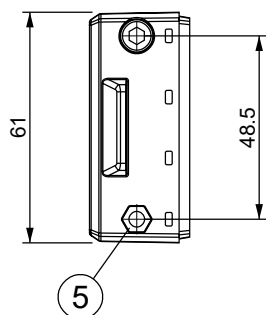
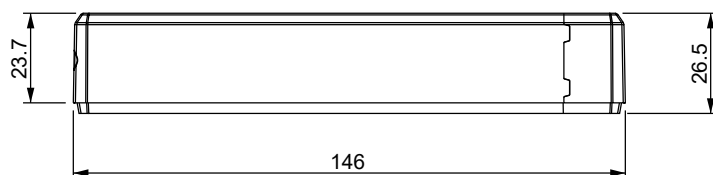
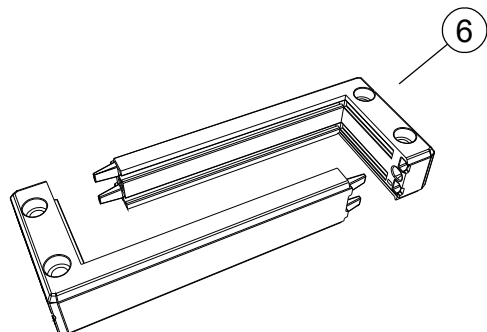
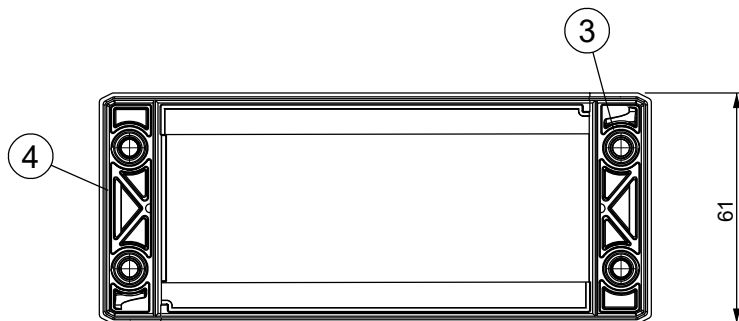
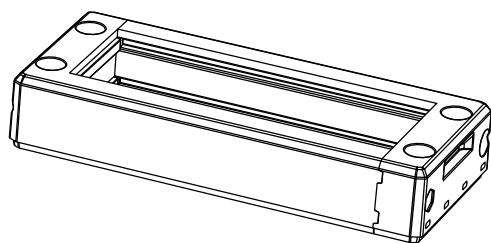

Id	Description	Material	Q.ty
1	DES 24 Top	PP + GF	1
2	DES 24 Bottom	PP + GF	1
3	DES 24 Gasket Top	TPE	1
4	DES 24 Gasket Bottom	TPE	1
5	Nut (Black dacromet finishing)	SS304	2
6	Screw Hex M5x0.8 L=140	SS304	2

	<b>IP66</b>	<b>NEMA 4X</b>	<b>NEMA 12</b>	<b>HL3</b> EN 45545-2				<b>UV</b> ISO 4892-2A		<b>IK10</b>	-40 +155 °C	
--	-------------	----------------	----------------	--------------------------	--	--	--	--------------------------	--	-------------	-------------------	--

**Flammability:** UL94-V0, self-extinguishing  
**Temperature:** -40°C ... +155°C  
**Properties:** halogen-free, silicone-free

Recommended cut-out:  
112 x 39 mm

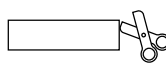

Available ATEX version:  
DES 24 A - 1731310024

Available with threaded inserts:  
DES 24 FT - 1731410024

Codice / Code

**1731010024**

Descrizione / Description

**DES 24**

Rev.  
003

Materiale / Material  
see table

Colore / Color  
Black

Peso / Weight (g)  
156.6

Unità di misura / Measure units  
mm

Formato / Format  
A4

Scala / Scale  
1:2



Data / Date  
12/10/2020

Numero foglio / Sheet number  
-

Numero progetto / Project number  
-

Disegn. / Drawn  
ravezzano@detas.com

Note / Notes  
-

QUESTO DISEGNO E LE SUE INFORMAZIONI SONO STRETTAMENTE RISERVATE DI PROPRIETÀ DETAS SPA.  
NON UTILIZZARE PER SCOPI DIVERSI DA QUELLI PER CUI SONO STATE FORNITE. DO NOT SCALE DRAWING.

A

B

C

D