

A

B

C

D

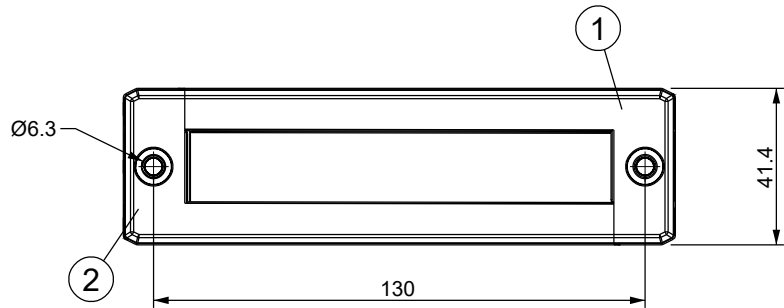
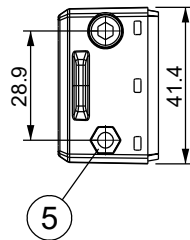
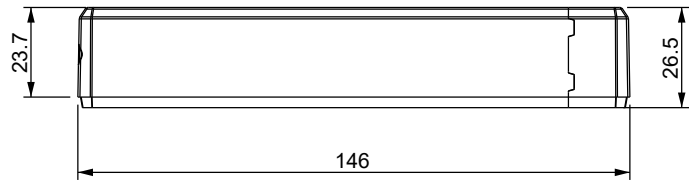
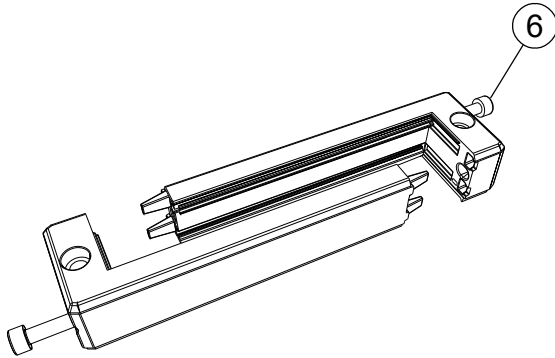
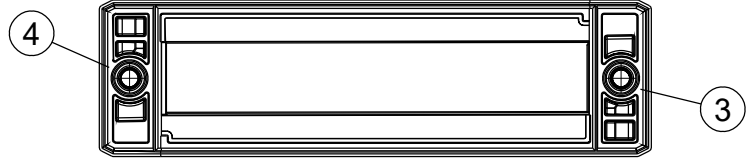
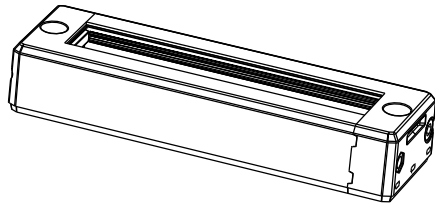

3

Id	Description	Material	Q.ty
1	DES L5 Top	PP + GF	1
2	DES L5 Bottom	PP + GF	1
3	DES L5 Gasket Top	TPE	1
4	DES L5 Gasket Bottom	TPE	1
5	Nut (Black dacromet finishing)	SS304	2
6	Screw Hex M5x0.8 L=140	SS304	2

	IP66	NEMA 4X	NEMA 12	HL3 EN 45545-2				UV ISO 4892-2A		IK10	-40 +155 °C	
--	-------------	----------------	----------------	--------------------------	--	--	--	--------------------------	--	-------------	-------------------	--

Flammability: UL94-V0, self-extinguishing
Temperature: -40°C ... +155°C
Properties: halogen-free, silicone-free

Recommended cut-out:
112 x 18 mm

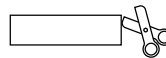

Available ATEX version:
DES L5 A - 1731310005

Available with threaded inserts:
DES L5 FT - 1731410005

Codice / Code

1731010005

Descrizione / Description

DES L5

Rev.
003Materiale / Material
see tableColore / Color
BlackPeso / Weight (g)
145.2Unità di misura / Measure units
mmFormato / Format
A4Scala / Scale
1:2Data / Date
12/10/2020Numero foglio / Sheet number
-Numero progetto / Project number
-Disegn. / Drawn
ravezzano@detas.comNote / Notes
-

QUESTO DISEGNO E LE SUE INFORMAZIONI SONO STRETTAMENTE RISERVATE DI PROPRIETÀ DETAS SPA.
 NON UTILIZZARE PER SCOPI DIVERSI DA QUELLI PER CUI SONO STATE FORNITE. DO NOT SCALE DRAWING.

A

B

C

D

1

2

3

4