

Black color version:
DES-PDM-Q/13B: 1732015614

ATEX grey version:
DES-PDM-QA/13G: 1732314613

ATEX black version:
DES-PDM-QA/13B: 1732315614

| Id | Description | Material | Q.ty |
|----|----------------|----------|------|
| 1 | Body | TPE | 1 |
| 2 | Internal frame | PA | 1 |

Flammability: UL94-V0, self-extinguishing
Temperature: -40°C ... +105°C
Properties: halogen-free, silicone-free

Recommended cut-out:
46 x 46 mm

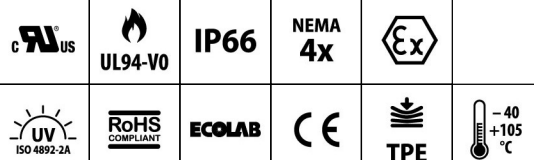
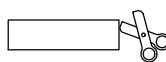

Codice / Code

1732014613

Descrizione / Description

DES PDM Q13G

Rev.
001

Materiale / Material
TPE / PA

Colore / Color
Grey

Peso / Weight (g)
-

Unità di misura / Measure units
mm

Formato / Format
A4

Scala / Scale
1:1

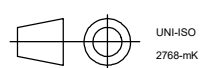

Data / Date
31/07/2020

Numero foglio / Sheet number
-

Numero progetto / Project number
-

Disegn. / Drawn
ravezzano@detas.com

Note / Notes
-

QUESTO DISEGNO E LE SUE INFORMAZIONI SONO STRETTAMENTE RISERVATE DI PROPRIETA' DETAS SPA. NON UTILIZZARE PER SCOPI DIVERSI DA QUELLI PER CUI SONO STATE FORNITE. DO NOT SCALE DRAWING.

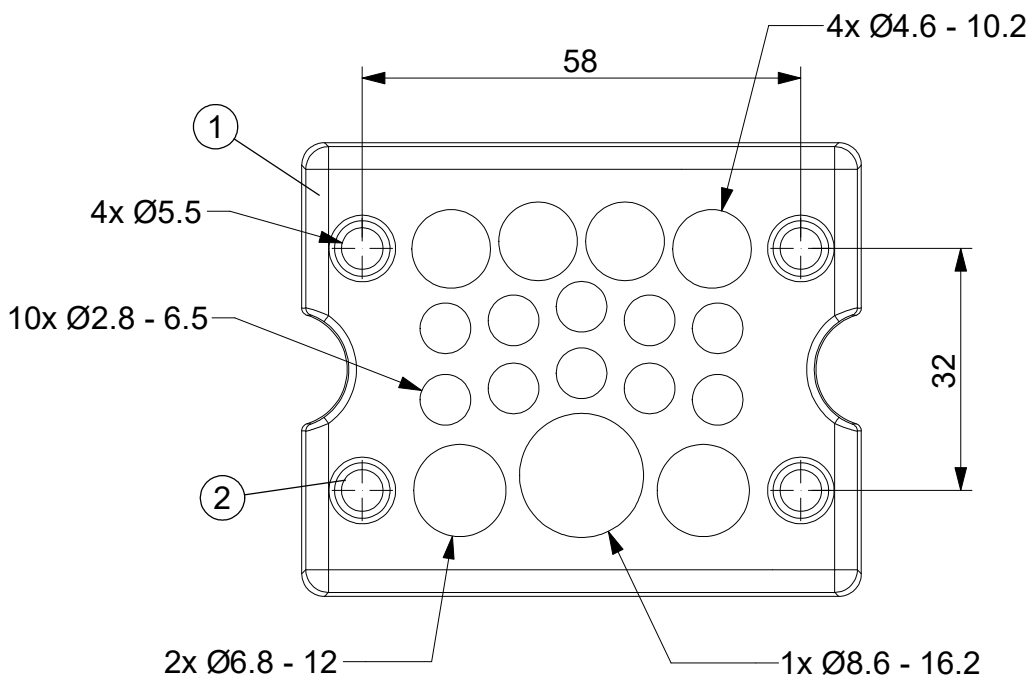
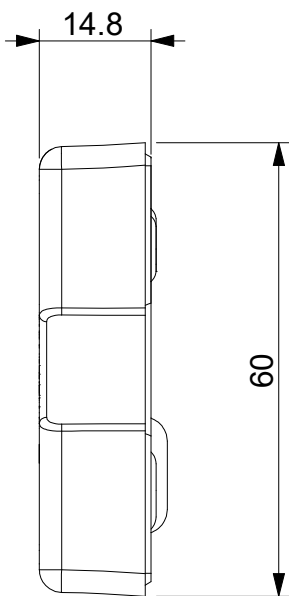
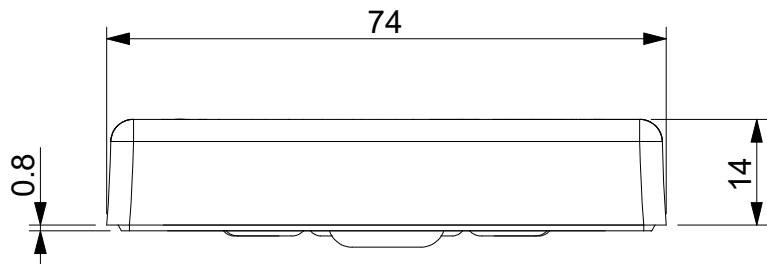
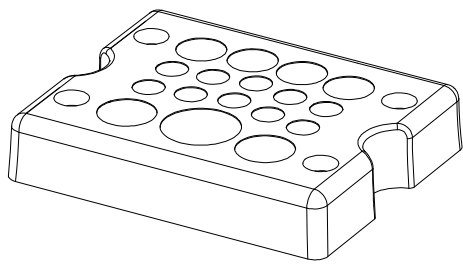

Black color version:
DES-PDM-Q/17B: 1732015618

ATEX grey version:
DES-PDM-QA/17G: 1732314617

ATEX black version:
DES-PDM-QA/17B: 1732315618

| Id | Description | Material | Q.ty |
|----|----------------|----------|------|
| 1 | Body | TPE | 1 |
| 2 | Internal frame | PA | 1 |

Flammability: UL94-V0, self-extinguishing
Temperature: -40°C ... +105°C
Properties: halogen-free, silicone-free

Recommended cut-out:
46 x 46 mm

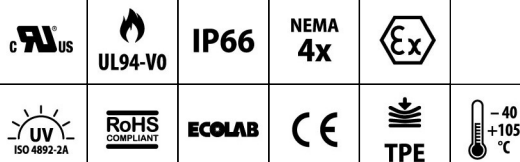
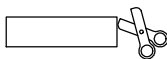

Codice / Code

1732014617

Descrizione / Description

DES PDM Q17G

Rev.
001

Materiale / Material
TPE / PA

Colore / Color
Grey

Peso / Weight (g)
-

Unità di misura / Measure units
mm

Formato / Format
A4

Scala / Scale
1:1



www.detasultra.com

QUESTO DISEGNO E LE SUE INFORMAZIONI SONO STRETTAMENTE RISERVATE DI PROPRIETÀ DETAS SPA. NON UTILIZZARE PER SCOPI DIVERSI DA QUELLI PER CUI SONO STATE FORNITE. DO NOT SCALE DRAWING.

Data / Date
31/07/2020

Numero foglio / Sheet number
-

Numero progetto / Project number
-

Disegn. / Drawn
ravezzano@detas.com

Note / Notes
-

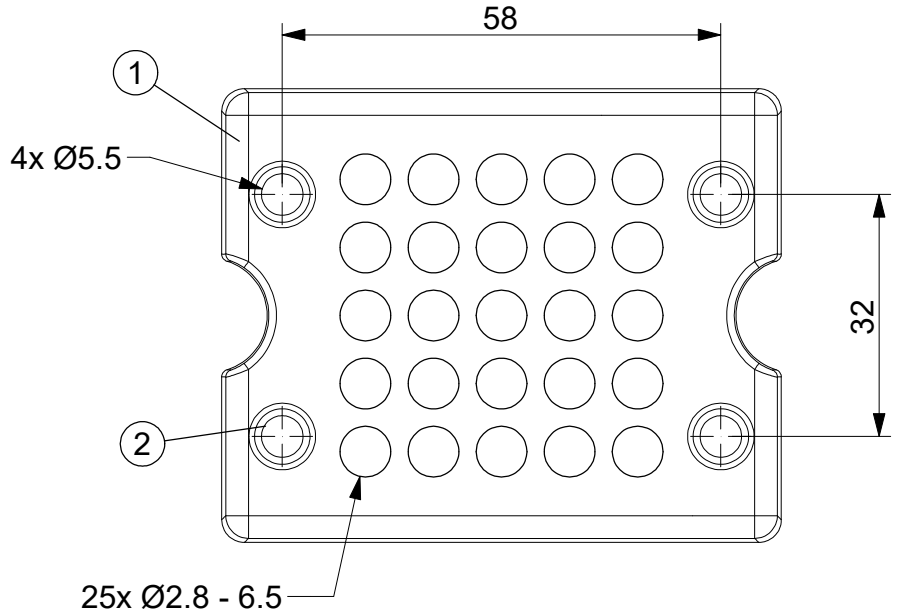
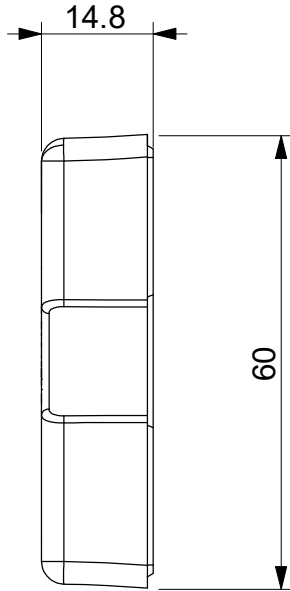
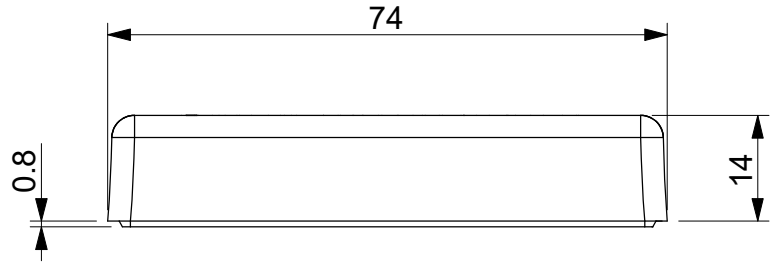
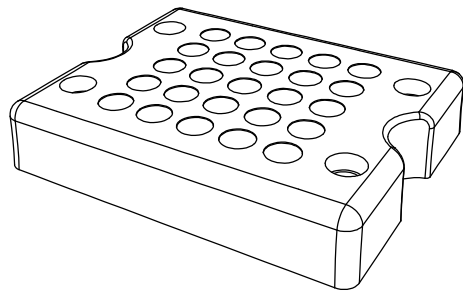

Black color version:
DES-PDM-Q/25B: 1732015626

ATEX grey version:
DES-PDM-QA/25G: 1732314625

ATEX black version:
DES-PDM-QA/25B: 1732315626

| Id | Description | Material | Q.ty |
|----|----------------|----------|------|
| 1 | Body | TPE | 1 |
| 2 | Internal frame | PA | 1 |

Flammability: UL94-V0, self-extinguishing
Temperature: -40°C ... +105°C
Properties: halogen-free, silicone-free

Recommended cut-out:
46 x 46 mm

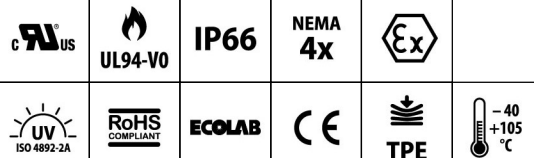
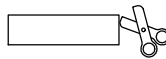

Codice / Code

1732014625

Descrizione / Description

DES PDM Q25G

Rev.
001

Materiale / Material
TPE / PA

Colore / Color
Grey

Peso / Weight (g)
-

Unità di misura / Measure units
mm

Formato / Format
A4

Scala / Scale
1:1

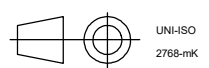

Data / Date
31/07/2020

Numero foglio / Sheet number
-

Numero progetto / Project number
-

Disegn. / Drawn
ravezzano@detas.com

Note / Notes
-

QUESTO DISEGNO E LE SUE INFORMAZIONI SONO STRETTAMENTE RISERVATE DI PROPRIETA' DETAS SPA. NON UTILIZZARE PER SCOPI DIVERSI DA QUELLI PER CUI SONO STATE FORNITE. DO NOT SCALE DRAWING.