

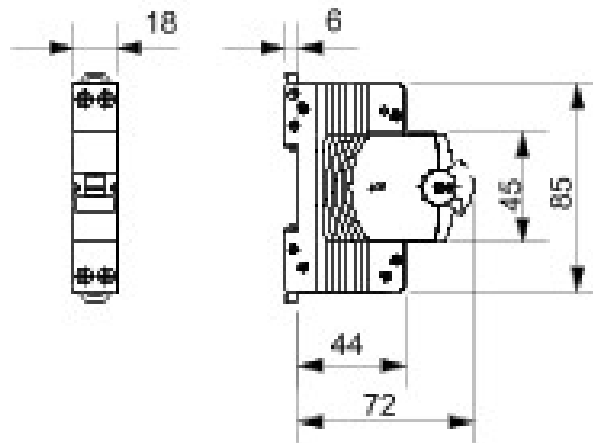

Description COMPACT MINIATURE CIRCUIT BREAKER
 Code MTC 60
 No. of poles 1P+N
 No. modules 1
 Rated current 32 A
 Curve C
 Rated voltage 230 V

Standard	EN 60898, EN 60947-2	Rated frequency (Hz)	50/60 Hz
Breaking capacity EN 60898 230V (Icn)	6000 A	Breaking capacity EN 60898 (Ics)	1 x Icn
Breaking capacity EN 60947-2 230V (Icu)	7.5 kA	Breaking capacity EN 60947-2 (Ics)	100% Icu
Insulation voltage	500 V	Rated impulse withstand voltage	4 kV
Minimum operating voltage	12V ac/dc	Maximum operating voltage	440V AC / 220V DC
Electrical endurance	10000	Mechanical endurance	20.000
Section rigid cable	<=1x16 - <=1x10+1x6 mm ²	Section flexible cable	<=1x10 - <=2x6 mm ²
Rated tightening torque	1.2 Nm	Operating temperature	-25 +60 °C
Stocking temperature	-40 +70 °C	Electrocod	1411

DIMENSIONAL



STANDARDS/APPROVALS



GEWISS S.p.A. Via A. Volta, 1
 24069 Cenate Sotto - Bergamo - Italy
 tel. +39 035 94 61 11 fax +39 035 94 69 09

www.gewiss.com
 sat@gewiss.com
 Last update 01/05/2019

Data, measures, designs and pictures are shown only as informativ purposes, and could be changed without previous notice