

Actuator

Series for Safety switches (SLK, SLM, ENK-VTU, ENM2-VTW)

Description **BETÄTIGER A2 KPL.**

Article number **3911702229**

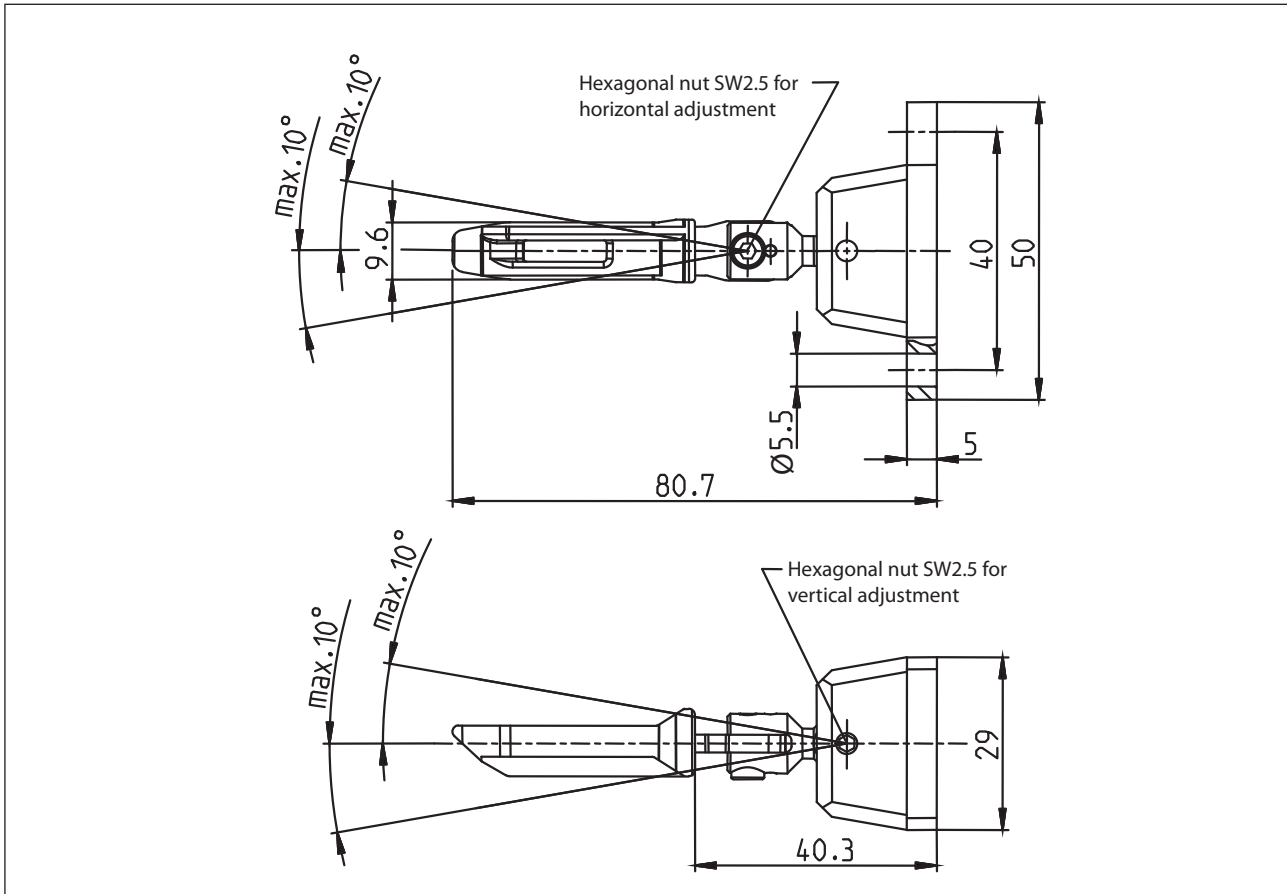

Mechanical data

Enclosure / Actuator	Steel/PA
Minimum actuating radius	R_{min} 150 mm

Notes

Changing the position of the spring loaded key (in steps of $4 \times 90^\circ$) is only possible when the whole actuator is not yet mounted to the ground. Allen key SW2,5 provided.