

# Rotation speed monitor 1-channel IM21-14EX-CDTRI

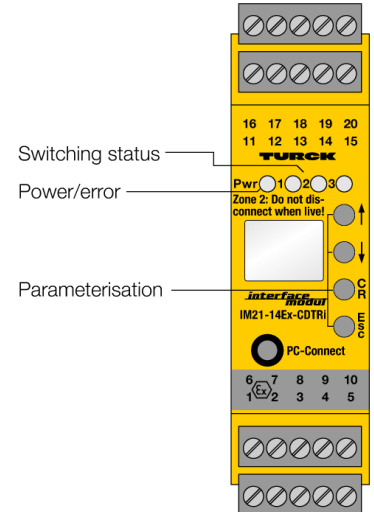
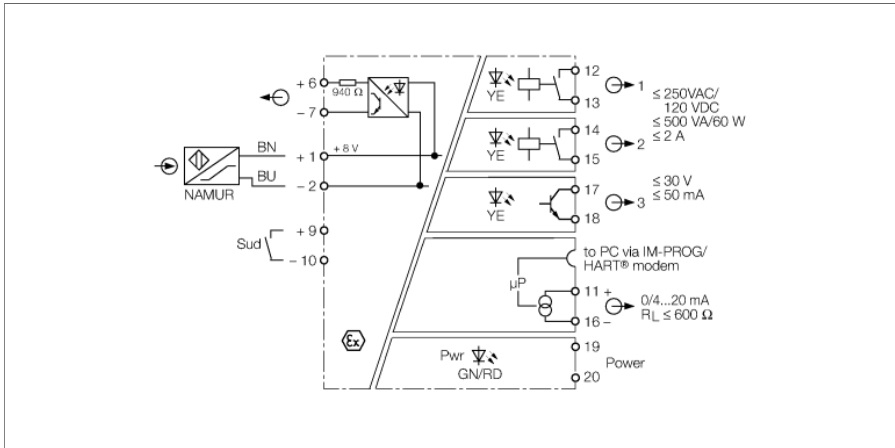

The rotation speed monitor IM21-14EX-CDTRI monitors frequencies, rotation speeds and pulse trains of rotating motor, gear or turbine parts according to over or undershoot of adjusted limit values. The current value is indicated on a display on the front of the device.

Intrinsically safe sensors acc. to EN 60947-5-6 (NAMUR) can be connected. Depending on the settings, the line is monitored for wire-break and/or short-circuit. In the event of an input circuit error the relays drop out, the transistor is blocked and the Pwr LED changes to red.

The device can be parametrized and configured via PC (FDT / DTM). For this, connect the device to the PC via the 3.5 mm jack on the front (the matching transmission cable IM-PROG III can be ordered separately from TURCK). In addition, a basic scope of parameters can be set via buttons and display on the front as well as via the HART<sup>®</sup> capable power interface

At each of the two relay outputs a predefined limit value can be monitored. The two relays also monitor overshoot/undershoot of window limits. The transistor output can also be used as a pulse divider. The measured value is permanently written to a ring buffer with space for 8000 values. The writing process is stopped with a predefined trigger event, like for example "excess of limit value". After that, the stored signal sequence can be read out.

A switching hysteresis is defined by setting a switch-on and off point. A switch-off delay can also be set to avoid shut down due to sudden frequency hops.

- Monitoring of limit values and ranges according to over and underrange
- Operating range 0.06...600,000 min<sup>-1</sup>
- Pulse output Ex [ic Gc] II C/II B
- Parameterized via PC (FDT/DTM), front-panel switch or HART
- Ring buffer for up to 8000 measured values
- Display
- Complete galvanic isolation
- Input reverse-polarity protected
- ATEX, IECEx, cFM<sub>US</sub>, TR CU, NEPSI, TIIS, Kosha
- Installation in zone 2

ID	7505651
Nominal voltage	Universal voltage supply unit
Operating voltage	20...250 VAC
Frequency	40...70 Hz
Operating voltage $U_s$	20...125 VDC
Power consumption	$\leq 3$ W

Monitoring range/Setting range	0.06...600,000 rpm
Max. input frequency	600000 min <sup>-1</sup>
Pulse time	$\geq 0.02$ ms
Pulse pause	$\geq 0.02$ ms
NAMUR input	
NAMUR	EN 60947-5-6
No-load voltage	8.2 VDC
Short-circuit current	8.2 mA
Input resistance	1 k $\Omega$
Cable resistance	$\leq 50$ $\Omega$
Switch-on threshold	1.75 mA
Switch-off threshold	1.55 mA
Wire breakage threshold	$\leq 0.06$ mA
Short-circuit threshold	$\geq 6.4$ mA

<b>Output circuits</b>	
Output current	0/4...20 mA
Load resistance current output	$\leq 0.6$ k $\Omega$
Fault current	0 / 22 mA adjustable
Output circuits (digital)	2 x relays (NO)
Output switching voltage relay	$\leq 30$ VDC / $\leq 250$ VAC
Switching current per output	$\leq 2$ A
Switching capacity per output	$\leq 500$ VA/60 W
Switching frequency	$\leq 10$ Hz

<b>Semiconductor output circuits</b>	
Output circuits (digital)	1 x transistor (potential-free, short-circuit proof)
Switching voltage	$\leq 30$ VDC
Switching current per output	$\leq 0.05$ A
Switching frequency	$\leq 10000$ Hz
Voltage drop	$\leq 2.5$ V
<b>Feed-forward pulse output</b>	
Voltage	$\leq 30$ V
Current	$\leq 10$ mA

<b>Response characteristic</b>	
Measuring accuracy (including linearity, hysteresis and repeatability)	$\leq 0.05$ % of full scale
Reference temperature	23 °C
Temperature drift analog output	0.0025 %/K

<b>Galvanic isolation</b>	
Test voltage	2.5 kV RMS

## Dimensions

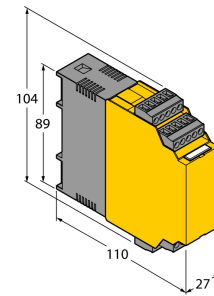

## Output relay – Load curve

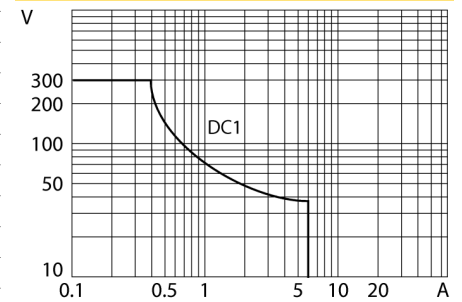

## Output relay – Electrical lifetime

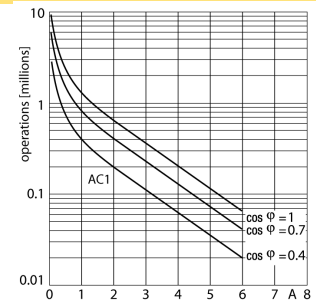

<b>Important note</b>	The values provided below indicate the relevant markings associated with the product's Ex certificates.
Ex approval acc. to conformity certificate	IBExU 07 ATEX 1132
Application area	II (1) G, II (1) D
Ignition protection category	[Ex ia Ga] IIC , [Ex ia Da] IIIC
Ex approval acc. to conformity certificate	IBExU 07 ATEX B010 X
Application area	II 3 G
Ignition protection type	Ex nA nC [ic Gc] IIC/IIB T4 Gc
Characteristic	linear
<b>Displays/Operating elements</b>	
Operational readiness	Green
Pulse input	Yellow
Error indication	red
<b>Mechanical data</b>	
Protection class	IP20
Flammability class acc. to UL 94	V-0
Ambient temperature	-25...+70 °C
	-25 ... +60 °C für FM
Storage temperature	-40...+80 °C
Dimensions	104 x 27 x 110 mm
Weight	249 g
Mounting instructions	DIN rail (NS35) or panel
Housing material	Plastic, Polycarbonate/ABS
Electrical connection	4 × 5-pin removable terminal blocks, reverse polarity protected, screw terminal
Terminal cross-section	1 × 2.5 mm <sup>2</sup> /2 × 1.5 mm <sup>2</sup>
Tightening torque	0.5 Nm

## Accessories

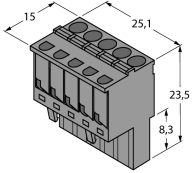
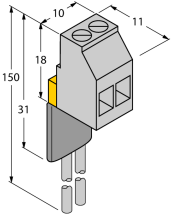
Type code	Ident-No.		Dimension drawing
IM-CC-5X2BU/2BK	7504031	Cage clamp terminals for IM modules (Ex-devices with 27 mm overall width); includes: 2 pcs. 5-pin blue terminals and 2 pcs. 5-pin black terminals.	
WM1 WIDER-STANDSMODUL	0912101	The resistor module WM1 meets the requirements for line monitoring between a mechanical contact and a TURCK signal processor. The input circuit of the signal processor is designed for sensors acc. to EN60947-5-6 (NAMUR) and equipped with a wire-break and short-circuit monitoring function.	
IM-PROG III	7525111	USB-compatible programming adapter for the FDT/DTM-based parametrization of HART-capable Turck devices; galvanic separation between the device to be parametrized and the PC	