

# 90 TMR

GWD6782  
GWD6783

Digital time switch

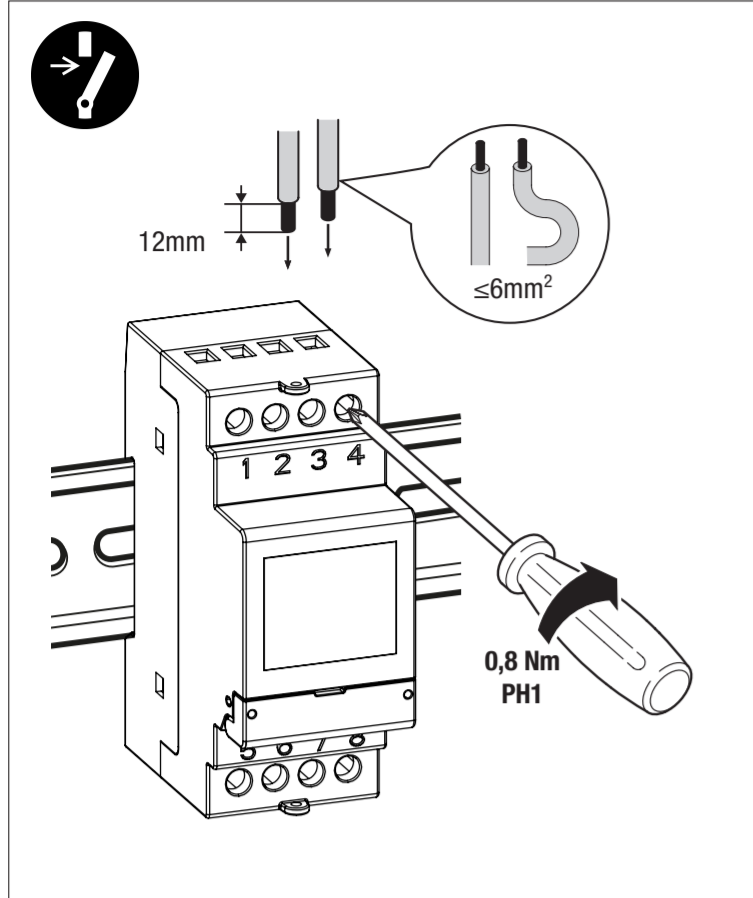

The digital clocks of the 90TMR range are electronic devices for managing electric circuits over time. They allow timer programming (time interval: daily or weekly). GWD6782 is fitted with one relay (1 channel) whereas GWD6783 has two relays (2 independent channels) (Fig.A). The clocks have an NFC interface so they can be coupled with mobile devices (smartphones or tablets). Thanks to the free app that can be downloaded from Google Play, the programming and settings can be managed directly from your smartphone, then all the data are transferred to the clock. The reverse procedure is also possible - copying the programming of a clock onto your mobile device.

The backup battery allows the settings to be maintained even in the event of a blackout. It can be replaced by removing the cover on the back of the clock. 90TMR range clocks are electronic devices that perform type 1B actions and are designed to work in places in overvoltage category III and pollution degree 2 (in accordance with EN 60730-1).

Code	Description
GWD6782	1-channel weekly time switch with NFC interface
GWD6783	2-channels weekly time switch with NFC interface

## SAFETY WARNINGS

For the installation and use of the product, follow these indications:

- The product must be installed by a qualified person, scrupulously respecting the connection diagrams given in this manual
- Once the product has been installed, it must be impossible to access the connection terminals without using specific tools
- Before accessing the connection terminals, make sure the wires are not live
- Do not connect or power the product if any part of it is damaged
- The product must be installed and started up in accordance with the electrical system regulations in force
- Do not use the product for purposes other than those indicated
- The electrical system upstream of the product must contain an overcurrent protection device
- The product can be used in places in measurement category III and pollution degree 2 (in accordance with CEI EN 60730-1)

## TECHNICAL CHARACTERISTICS

- Power supply: 230V AC (-15% to +10%) 50/60 Hz
- Draw:
  - GWD6782: 1W (3.5 VA)
  - GWD6783: 1.5W (5.5 VA)
- 3V lithium backup battery, type CR2032 (replaceable)
- Output:
  - GWD6782: 1 changeover momentary relay with maximum switchable load 16(10)A / 250V
  - GWD6783: 2 changeover momentary relays with maximum switchable load 16(10)A / 250V
- LCD display with backlighting (activated from the mains supply)
- NFC communication interface
- Storable programs:
  - GWD6782: 120 operations
  - GWD6783: 120 operations (divided over the 2 channels)
- Type of action: 1B
- Operating temperature: -20 to +50°C
- Operating humidity: 20 - 90% (non-condensing)
- Storage temperature: -10 to +70°C
- Container: 2 DIN modules
- Degree of protection: IP20
- Insulation: reinforced between accessible parts (front) and all the other terminals

## DESCRIPTION OF THE DISPLAY AND KEYPAD (Fig. B)

- General indications
- Time
- Channel 1 / channel 2 status
  - On/Off channel status
  - switchover blocked
  - random switchover active
  - holiday program active
  - impulse program active
  - manual program active
- Day of the week (DAY)
- Activate the display
  - Access the menu
  - ESC (1 level back)
- Button key "C1": decreases the data item/menu back/channel 1 switchover/channel 1 block
  - Button key "C2": increases the data item/menu forward/channel 2 switchover/channel 2 block
- Confirm selection
- Reset hardware

"OK" + "C1" (3 sec): random switchover of channel 1

"OK" + "C2" (3 sec): random switchover of channel 2

## INITIAL START-UP

- When the product is taken out of its packaging, it will be switched off. Press **OK** and wait a few moments for the display to be activated.
- The set language is Italian. To change it, hold the **OK** button key for at least 3 seconds. Choose from Italian, English, Spanish, French or German, then confirm with **OK**.
- Make the connections as per the diagrams (Fig. A) in this manual.
- Power the product; the backlighting will come on permanently.
- The backup battery allows the product to start up with the correct date and

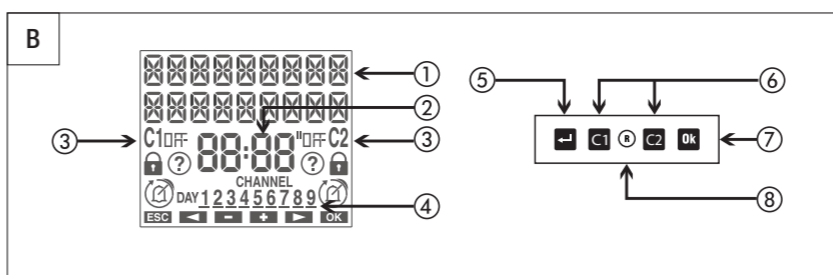
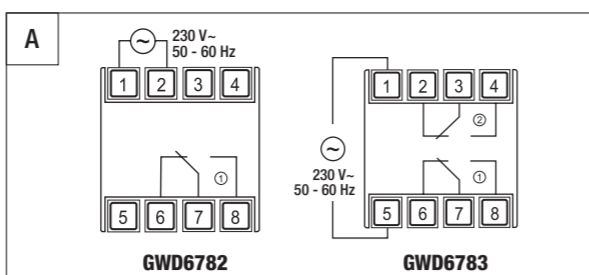

time. The other settings are:

Date:	- format: DD/MM/YY - 1st day of the week: Monday
Summer time changeover:	- summer time start: last Sunday of March, 2.00 am - summer time end: last Sunday of October, 3.00 am
Random switchover:	- minimum: 1 minute - maximum: 5 minutes

Keypad lock with PIN: deactivated (---)

NFC interface: active

## HOMEPAGE (or main page)

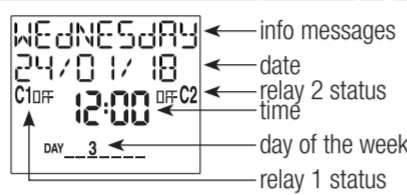

## Info messages

- day of the week
- product ID code and serial number
- battery status (only if run down)
- "NO SUPPLY"

\* Only if the product is not powered from the mains. In this case, the backlighting is not active and the relay is OFF.

- Press the button key **OK** to access the product menus
- OK** and **C1** to swap the status of channel 1 and channel 2 (only on GWD6783)

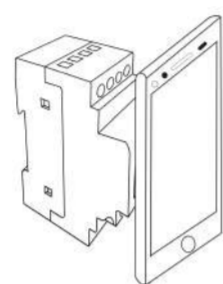

NB: the NFC interface is only active when the product is showing the homepage (main). The range of action of the NFC interface is purposely limited: in order for the time switch and smartphone to communicate, the smartphone must be resting on the time switch display.

Go to the store of your device and install and launch the free "TimerOn - Gewiss" app.

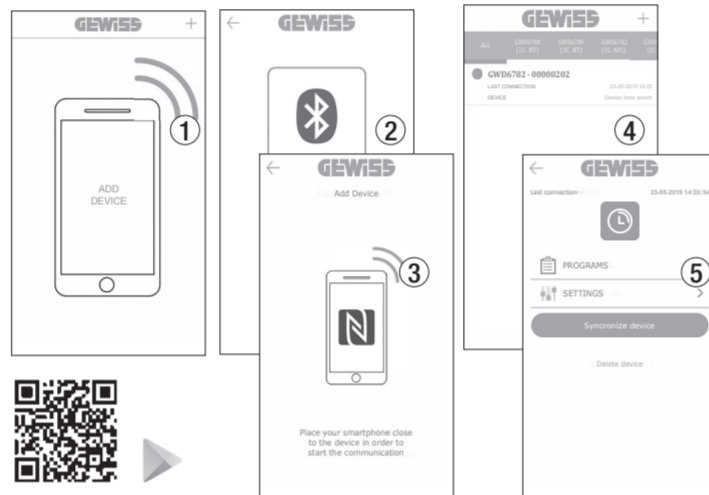

- At the start, the app will show a list of the associated devices (both Bluetooth and NFC). To associate a new device, press on the "+" symbol.
- On the "Choose the type of connection" screen, select NFC.
- Rest your smartphone on the display of the time switch you want to associate.

NB: every device is identified by its product code (e.g. GWD6782) and serial number (e.g. 0000020). This information can be viewed on the product homepage.

ATTENTION: make sure the display is showing the homepage. If it isn't, the NFC interface won't be active and the device won't be visible.

- The app shows the time switch detected; tap on the device to complete the association. Once the procedure has been completed, the product will be added to the list of associated devices. Select the required product from the list.

- The app shows the homepage of the selected product. From this page, you can:
  - Create new programs that will then be copied in the product
  - View the parameters and associate an alias (a name identifying the clock, such as "Timer Belluno") with the product

## DESCRIPTION OF THE MENUS

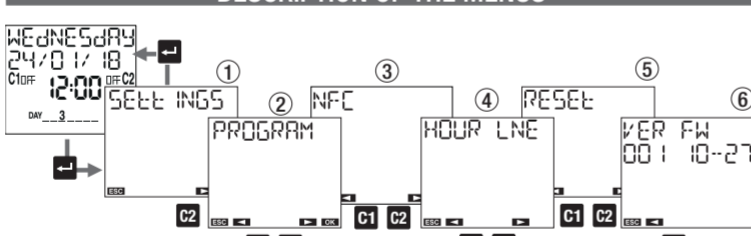

- The "Settings" menu is used to modify: the language, date, time, summer time, minimum and maximum time gap between two random program switchovers, PIN for keypad locking.
- The "Programming" menu is used to set a new program or to check, copy, modify or delete an existing program.
- The "NFC" menu is used to enable the NFC communication interface.
- The "Hour-counter" menu is used to check the operating hours (relay ON) of the loads connected to the relays.
- The "Reset" menu is used to reset the settings, programming operations implemented and hour-counter.
- The "Ver FW" menu is used to check the firmware version installed on the device.

## SETTINGS MENU

The "Settings" menu allows you to view (and modify if necessary) the general product operating settings:

- language
- date
- time
- automatic summer time changeover
- time gap between two random switchovers
- button key protection with a PIN

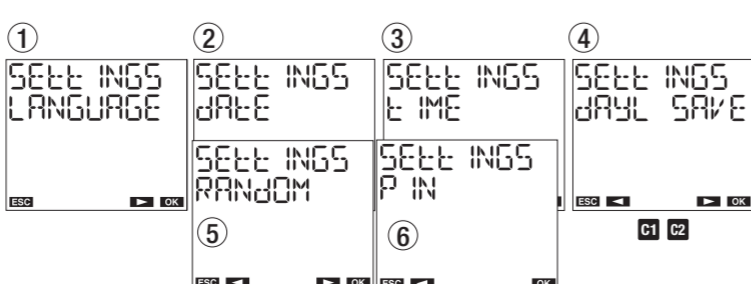

## LANGUAGE SETTING MENU

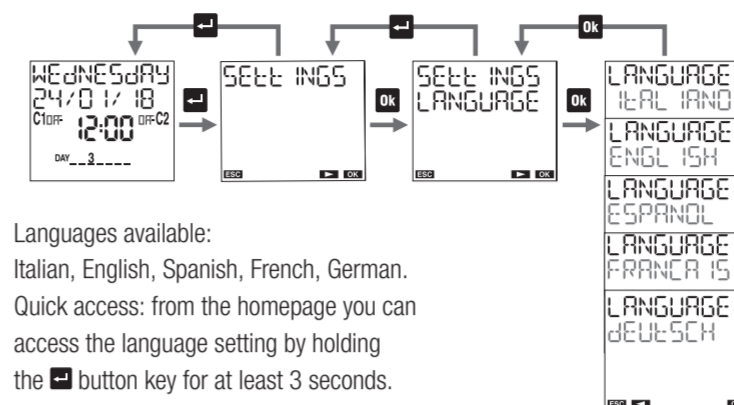

Languages available:

Italian, English, Spanish, French, German.

Quick access: from the homepage you can access the language setting by holding the **OK** button key for at least 3 seconds.

## DATE SETTING MENU

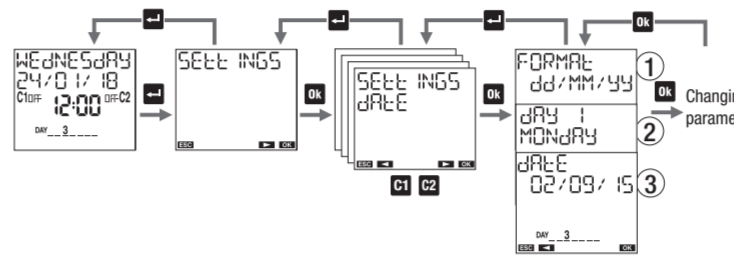

Modifying the parameters

- Possible date formats: day-month-year (dd/mm/yy), year-month-day (yy/mm/dd), month-day-year (mm/dd/yy).
- Choose which is the first day of the week, by convention. For instance in Italy it's Monday, but in the United Kingdom it's Sunday.
- Enter the date: day, month, year.

## TIME SETTING MENU

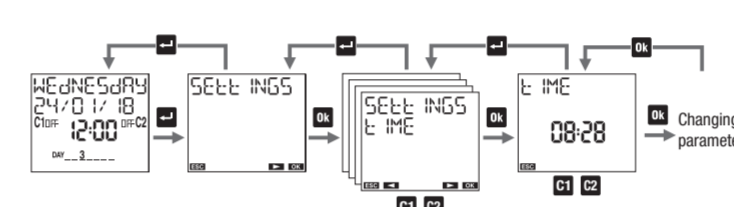

Modifying the parameters

Set the time: hours, minutes.

## SUMMER/WINTER TIME CHANGEOVER SETTING MENU

The changeover from summer time to winter time and vice versa can be made automatically. In this case, the product:

- moves forward one hour in the changeover from winter time to summer time
- moves back one hour in the changeover from summer time to winter time

For each time changeover, it's necessary to specify:

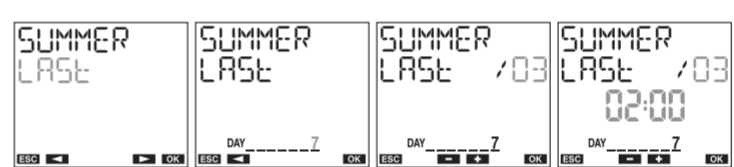

the week of the month when the change occurs (first, second, third, fourth, last)

the day of the week (Monday: 1, Tuesday: 2, ...)

the month

hours and minutes

For example, in Italy summer time begins the last (LAST) Sunday (7) of March (03) at 02:00 pm, and ends the last (LAST) Sunday (7) of October (10) at 03:00 am.

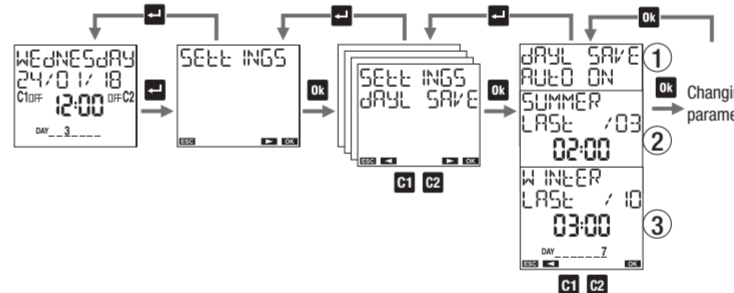

Modifying the parameters

- Choose whether to activate (RULE ON) or deactivate (RULE OFF) the automatic time changeover.
- Set the date and time for the winter-summer time changeover.
- Set the date and time for the summer-winter time changeover.

## RANDOM SWITCHOVER SETTING MENU

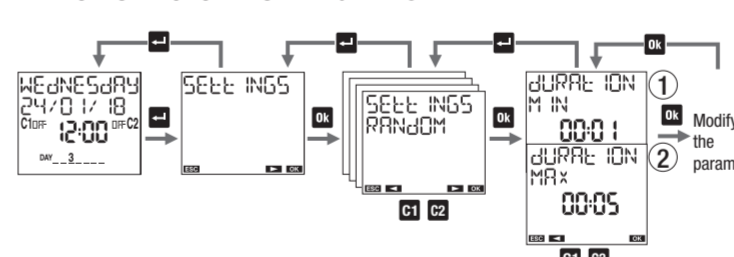

With the "random switchover" function (activated with the combination of button keys indicated in "Description of the display and keypad"), the relative relay switches over automatically and at random time gaps.

This menu is used to define the minimum and maximum time gap between two random switchovers.

The factory setting is 1 minute minimum and 5 minutes maximum.

Modifying the parameters

- Set the minimum time gap (the value must be between 1 minute and the maximum gap).
- Set the maximum time gap (the value must be between the minimum gap and 23.59 hours).

NB: if the minimum and maximum values are the same, the switchovers will take place at fixed intervals.

## PROTECTION PIN SETTING MENU

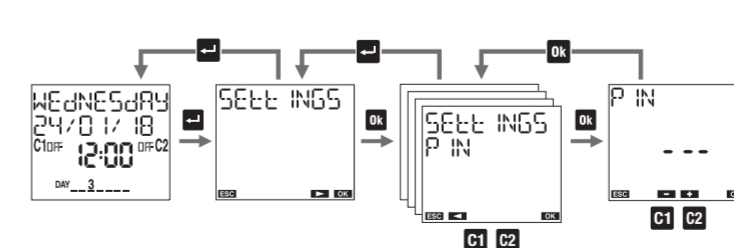

The protection code (PIN) allows the keypad to be blocked, preventing any modifications by unauthorised persons. When PIN protection is active, press any button key and then enter the PIN; the correct PIN will unblock the keypad (which will be blocked again automatically if 3 minutes elapse without any button key being pressed).

To activate PIN protection:

- set a value between 000 and 999

To deactivate PIN protection:

- set "----" (you can find it before 000 or after 999)

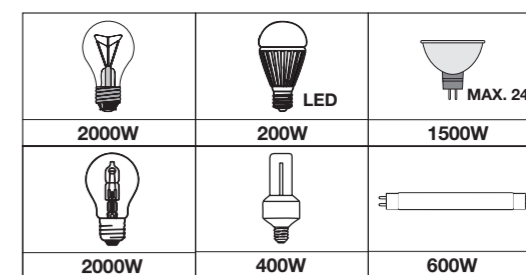

NB: if you forget the PIN code, the product can only be unlocked by making a hardware reset (see the RESET paragraph).

## PROGRAM MENU

The "Program" menu is used to:

- create a new program
- check the programs created
- modify or delete a program created
- copy all the programs of channel 1 onto channel 2, or vice versa (only for GWD6783)
- delete all the programs of a channel

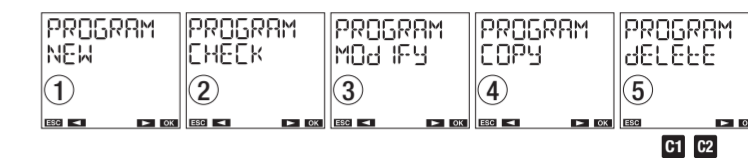

## Types of program

- ON/OFF program: involving a relay switchover to ON and then to OFF. The frequency may be daily (every day, in the same way) or weekly (every week, in the same way).
- IMPULSE ON program: involving a relay switchover to ON for maximum 59 seconds. The frequency may be daily (every day, in the same way) or weekly (every week, in the same way).
- IMPULSE OFF program: involving a relay switchover to OFF for maximum 59 seconds. The frequency may be daily (every day, in the same way) or weekly (every week, in the same way).
- HOLIDAY program: a period of time with a start moment and an end moment, within which all the programmed switchovers (of that channel) are disabled. The relay remains in the OFF position (holiday OFF) or the ON position (holiday ON).

**Important:** ON and OFF impulses cannot co-exist on the same channel (if there is already an ON impulse, you cannot save an OFF impulse, and vice versa).

**Important:** holiday ON programs and holiday OFF programs cannot co-exist on the same channel (if there is already a holiday ON program, you cannot save a holiday OFF program, and vice versa).

## Program priority

The priority of the programs defines how the time switch manages a situation where programs with different frequencies are implemented at the same time (1 indicates the highest priority).

Program	Date	Yearly	Monthly	Weekly	Daily
Holiday			1		
Impulse				2	3
On/Off				4	5

## Priority for on/off programs

If a single channel contains on/off programs with different frequencies (daily or weekly), to be implemented on the same day, only the program with the highest priority is run.

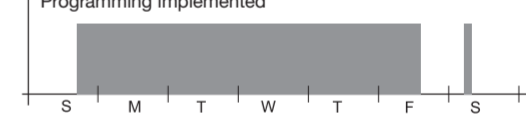
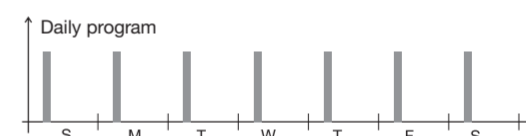

The example shows that the daily operation of Monday isn't run because the start of a weekly program is planned for the same day (even if the daily program for Monday starts and ends before the start of the weekly program). The daily program of Sunday, on the other hand, is run because it's the only one planned for that day.

## Holiday program

The holiday program starts and ends at precisely the times specified.

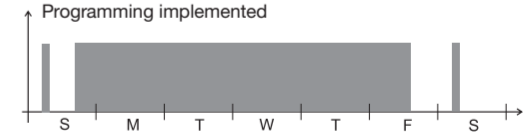
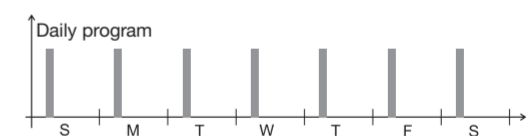

## PROGRAM MENU: NEW

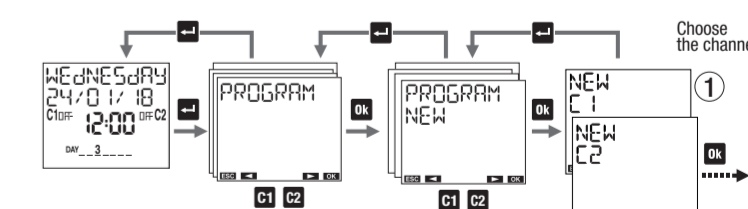

- Choose the channel to be programmed (only for GWD6783)

Program menu: new daily time

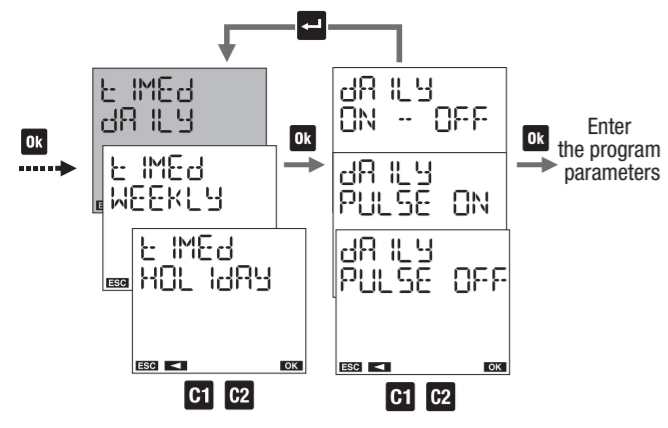

- Program parameters
- on/off: ON time and OFF time
  - impulse on: time and duration of the impulse (max 59 seconds)
  - impulse off: time and duration of the impulse (max 59 seconds)

Program menu: new weekly time

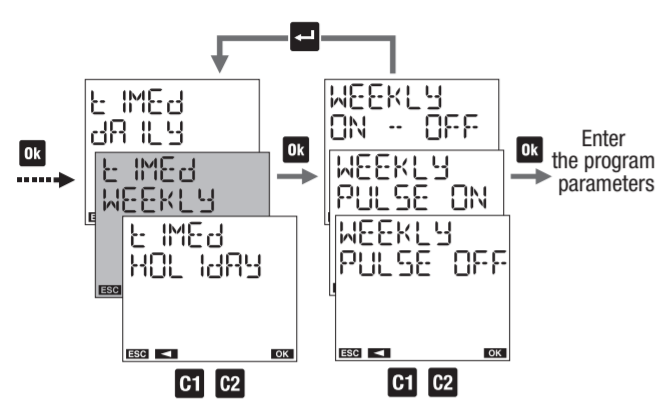

- Program parameters
- on/off: ON day(s) and time, OFF day(s) and time
  - impulse on: impulse day(s) and time, impulse duration (max 59 seconds)
  - impulse off: impulse day(s) and time, impulse duration (max 59 seconds)

- How to select the days
- Scroll through the days of the week from 1 to 7:
- press **C2** to move on to the next day without selecting the current one
  - press **C1** to select/deselect the current day and move on to the next one

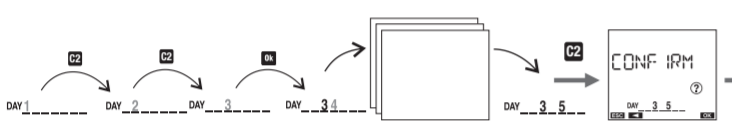

Program menu: new holiday time

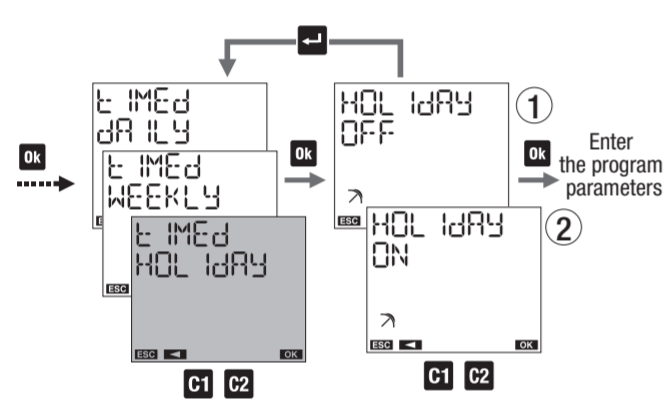

- 1) HOLIDAY OFF: the relay remains OFF from the start of the holiday program to the end.
- 2) HOLIDAY ON: the relay remains ON from the start of the holiday program to the end.

- Program parameters
- program start
  - program end

How to choose the day(s) in a holiday program

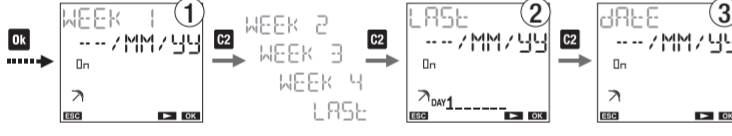

- 1) To set the program:
  - in the first, second, third, fourth or last week of the month, in the day(s) (Monday, ...) of that week
  - of the month specified (MM for every month)
  - of the year specified (YY for every year)

NB: in this case, the holiday program must start and end on the same day. Otherwise, ERROR03 will be displayed.

- 2) To set the program the last day:
  - MM/YY of every month of every year
  - YY/YY of the month YY specified, of every year
  - MM/ZZ of every month of the year ZZ specified
  - YY/ZZ of the month YY specified of the year ZZ specified

- 3) To set the program on day XX (1,2,3...):
  - xx/MM/YY of every month of every year
  - xx/YY/YY of the month YY specified, of every year
  - xx/MM/ZZ of every month of the year ZZ specified
  - xx/YY/ZZ of the month YY specified of the year ZZ specified

PROGRAM MENU: CHECKING

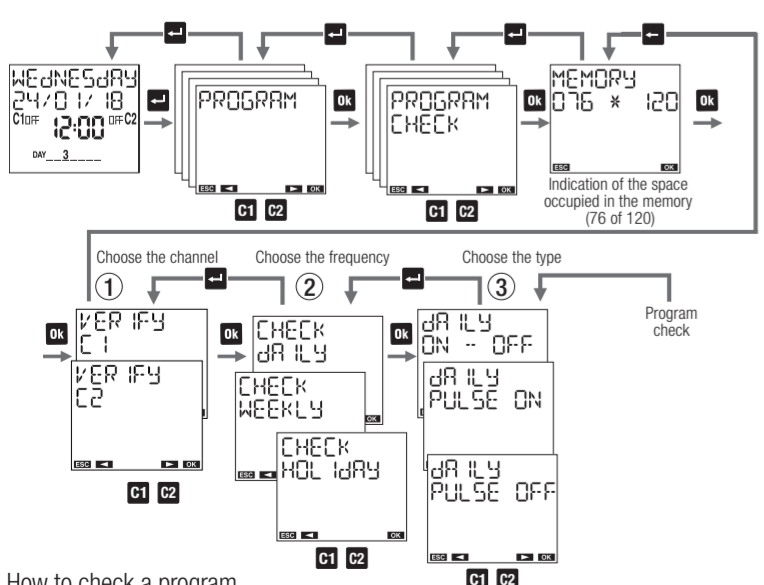

- How to check a program
- 1) choose the channel (only for GWD6783)
  - 2) choose the frequency: daily, weekly, holiday.
  - 3) choose the type: on/off, impulse on, impulse off.

- NB: a program requires several screens in order to be fully visualised:
- press **C1** to move from the first to the second part of a single program
  - press **C1** and **C2** to move from one program to another

PROGRAM MENU: MODIFYING

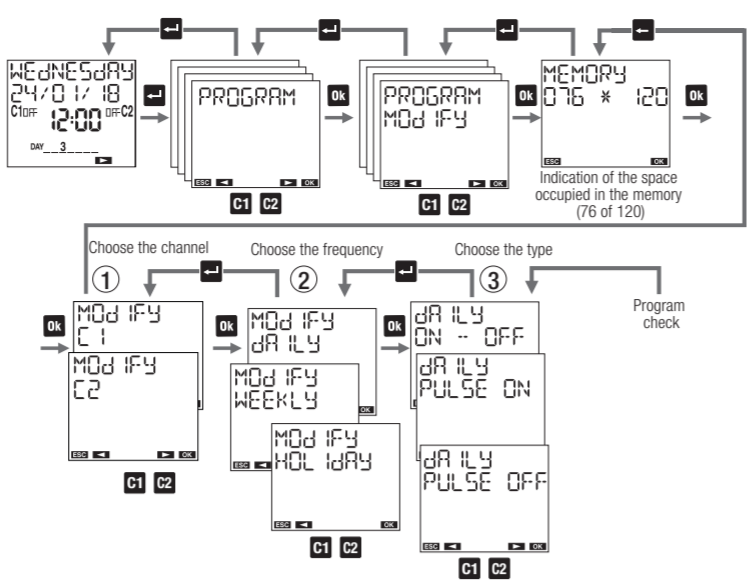

- How to modify or delete a program.
- 1) choose the channel (only for GWD6783)
  - 2) choose the frequency: daily, weekly, holiday.
  - 3) choose the type: on/off, impulse on, impulse off.

- NB: a program requires several screens in order to be fully visualised:
- press **C1** to move from the first to the second part of a single program
  - press **C1** and **C2** to move from one program to another

- To modify: hold the **C1** button key for at least 3 seconds.
- To delete: hold the **C1** and **C2** button keys simultaneously for at least 3 seconds

PROGRAM MENU: COPYING (ONLY FOR GWD6783)

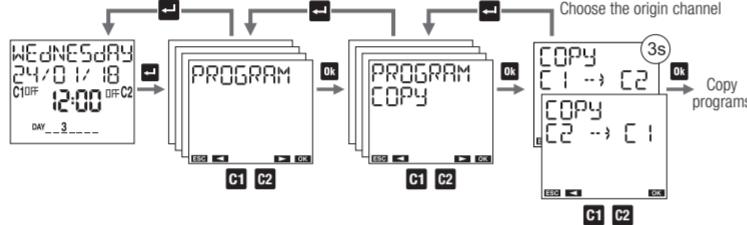

The "Copy" menu is used to copy programs from one channel (origin channel) to the other (destination channel).

NB: the programs already stored on the destination channel will be deleted.

PROGRAM MENU: DELETING

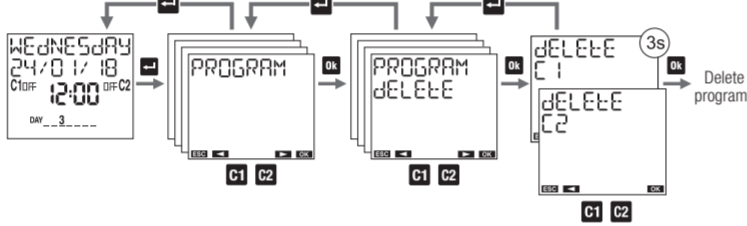

The "Delete" menu is used to delete all the programs stored on the channel specified, by holding the **C1** button key for at least 3 seconds.

NB: to delete a single program, refer to the "Modify" menu.

NFC MENU

- The NFC menu is used to enable or disable the NFC interface.
- To enable the NFC interface:
- 1) set NFC ON
- ATTENTION: in order for the NFC interface to be active, the product must be displaying the homepage; this means the NFC interface is not active while you are navigating the product menus. To ensure stable communication, rest your smartphone on the time switch display.
- To disable the NFC interface:
- 2) set NFC OFF

In this way, there is no communication between your mobile device and the time switch.

The time switch works with the settings and programming already defined; any variations, or the creation of new programs, must be implemented directly on the product keypad.

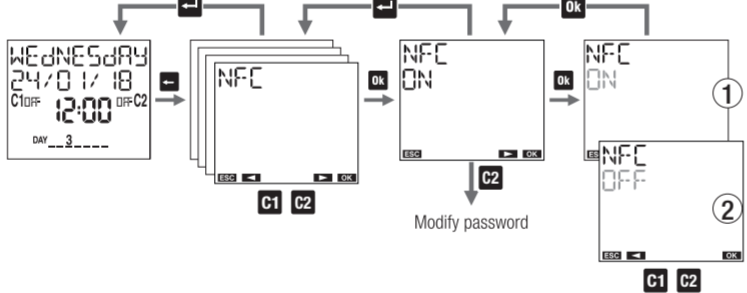

HOURLY-COUNTER MENU

The "Hour-counter" menu is used to view the operating hours (relay ON) of the loads connected. The maximum value of the hour-counter is 99999 hours (approx. 11 years); when this limit has been reached, it resets automatically.

- To reset the hour-counter:
1. select the required channel (only for GWD6783)
  2. hold the **C1** button key for 3 seconds, until the display shows "HOUR COUNTER DELETE"
  3. confirm by pressing **C1** (or press **C2** to quit without resetting)

NB: the hour-counters can all be reset simultaneously from the "Reset" menu.

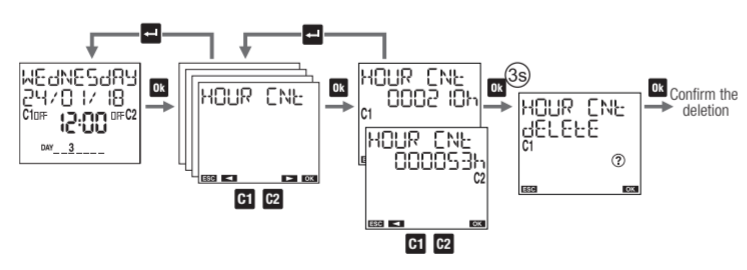

RESET MENU

The "Reset" menu is used to reset the initial status of the device.

- Resets available:
- 1) Settings reset: deletes all the settings made (apart from the language and the PIN)
  - 2) Hourly program reset: deletes all the hourly programs saved
  - 3) Holiday program reset: deletes all the holiday programs saved
  - 4) Hour-counter reset: resets the hour-counters of all the channels
  - 5) Total reset: performs all the resets listed above, and also deletes the language and protection PIN

There is also another reset, of the hardware, that allows the device to be restarted if it responds to the pressing of the keys in an unexpected manner. The programming and settings are not lost (only the date and time are lost).

To make a hardware reset:  
use a pointed object to press the "R" button key

The hardware reset is also handy if you forget the protection PIN; it unlocks the keypad for 3 minutes, so you can access the relative menu and find/deactivate the PIN.

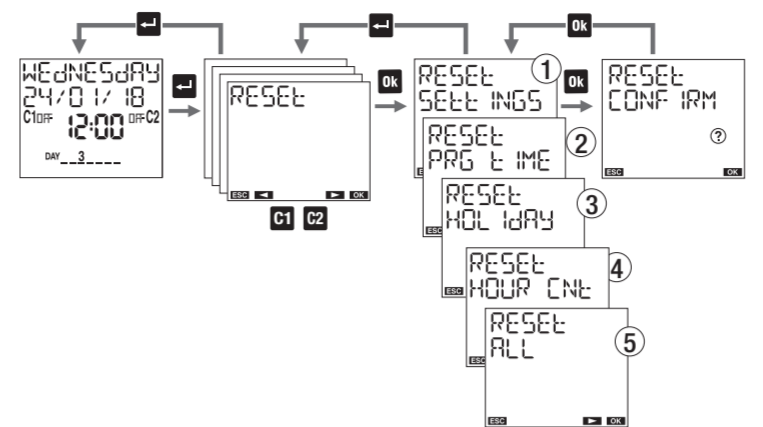

FIRMWARE MENU

Shows the firmware version installed on the device, where:  
022 is the revision number  
05 is the month  
20 is the day

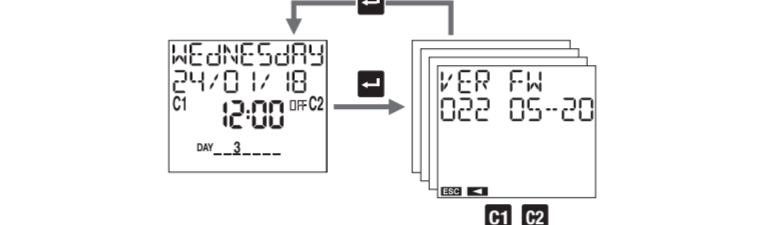

ERROR SIGNALLING

When the programs are being set, the following error messages may appear if the values entered are contradictory:

- ERROR001: ON and OFF operations with different frequencies (each ON operation must have a corresponding OFF operation)
- ERROR002: Simultaneous ON and OFF operations on a single program
- ERROR003: At least two consecutive ON operations on a single program / at least two consecutive OFF operations on a single program
- ERROR004: Invalid date
- ERROR005: Insufficient memory
- ERROR006: Attempt to set an ON impulse on a channel where there is already an OFF impulse (see Program Priority in the Program menu)
- ERROR007: Attempt to set an OFF impulse on a channel where there is already an ON impulse (see Program Priority in the Program menu)
- ERROR008: Attempt to set a holiday ON program on a channel where there is already a holiday OFF program (see Program Priority in the Program menu)
- ERROR009: Attempt to set a holiday OFF program on a channel where there is already a holiday ON program (see Program Priority in the Program menu)
- ERROR010: Attempt to set a holiday program with ON and OFF operations on different days of the week (see New Holiday Time)
- ERROR030: Memory access error\*

\* In this case, make a hardware reset. If the error persists, contact Gewiss Customer Service (tel. +39.035.946111).

MANAGING THE BATTERY

When the battery is almost run down, the word BATTERY will appear on the first row of the display. When this happens, replace the battery as soon as possible.

- Use CR2032 type batteries only.**
- To replace the battery:
- disconnect the power supply
  - remove the battery compartment cover by rotating it anti-clockwise, then replace the battery
  - rotate the cover clockwise to reposition it
  - reconnect the power supply

**Attention:** do not use metal objects (such as screwdrivers) to remove the battery, as this may annul the charge reserve and therefore cause the data and time info to be lost.

**Attention:** to avoid losing the date and time setting, the battery must be replaced within 60 seconds (the maximum power supply disconnection time).

REGULATORY REFERENCES

- Conformity with the following EC Directives:  
2014/35/EU (LVD)  
2014/30/EU (EMCD)  
is declared with reference to the standardised Regulation EN 60730-2-7.