

E.I.C.

*Electrical
Importing
Company*



LIMIT SWITCH RANGE



- Metal & plastic bodies
- Wide range of metal & plastic actuators
- Slow & snap-action contacts
- Plastic body chemical resistant & self-extinguishing
- High IP ratings IP65/67 available
- Plastic limit switches, insulation protection
- Metal limit switches, high mechanical loads
- Compatible with safety relays
- Variety of sizes to suit confined spaces through to larger cable distribution units

Introduction

The Bernstein limit switch range delivers the perfect solution for various different industries. Offering metal limit switches and plastic limit switches, both with a variety of actuator options.

The scope of application for limit switches has changed over time. Whereas limit switches were previously used for the purposes of detecting end positions, today they are increasingly assuming functions designed to protect persons and products in machine, equipment and plant construction.

Safety Relays can in conjunction with some limit switches provide up to Safety Category 4 (Performance Level e). A summary of safety relays is located at the end of this catalogue.

Bernstein is an established manufacturer of high quality electromechanical low voltage switching devices. Their products are used in a diverse range of applications, ranging from lift construction through wood-working and packaging machines through to machine tools.

This catalogue shows a wide range of limit switch sizes, different actuators and contact settings. Bernstein is constantly innovating their product range, so contact E.I.C. if you have a requirement not outlined in this catalogue.

For specific detail on the switches listed, www.eicnz.com has datasheets available.

Contents

Introduction & Contents	Page 2
Summary	Page 3
IN65 Series	Page 4
I49 Series	Page 8
C2 Series	Page 10
Ti2 Series	Page 12
I88 Series	Page 14
ENK Series	Page 18
GC Series	Page 22
ENM2 Series	Page 26
SN2 Series	Page 29
D Series	Page 30
Safety Relays	Page 32

Summary Plastic Body



Page 4 **NEW**

IN65 Series

- Plastic body / metal head
- 65.5 x 31 x 30.5mm body
- 20/22mm screw centres
- Standard size switch
- IP67
- Class II double insulated
- M20 cable entry



Page 8 **NEW**

I49 Series

- Plastic body
- 49 x 30 x 16mm body
- 20mm screw centres
- Slim design
- IP67
- Class II double insulated
- 1m cable



Page 10

C2 Series

- Plastic body
- 34 x 26 x 21mm body
- 15mm screw centres
- Miniature switch
- IP20
- Class II double insulated
- 8.5 x 3.5mm cable entry



Page 12

Ti2 Series

- Plastic body
- 45 x 30 x 27mm body
- 22/23mm screw centres
- Compact switch
- IP65
- Class II double insulated
- M16 cable entry



Page 14

I88 Series

- Plastic body
- 62 x 31 x 30.5mm body
- 20/22mm screw centres
- Standard size switch
- IP65
- Class II double insulated
- M20 cable entry



Page 18

ENK Series

- Plastic body
- 73.5 x 40 x 40mm body
- 30mm screw centres
- Metal actuators
- IP65
- Class II double insulated
- M20 cable entry

Metal Body



Page 22

GC Series

- Metal body
- 72 x 36 x 32.5mm body
- 25mm screw centres
- Compact Switch
- IP65
- M20 cable entry



Page 26

ENM2 Series

- Metal body
- 77.5 x 40 x 42mm body
- 30mm screw centres
- Standard size switch
- IP65
- M20 cable entry



Page 29

SN2 Series

- Metal body
- 70.5 x 58 x 35.5mm body
- 40.5/48mm screw centres
- Spacious connection area
- IP65
- 3 x M20 cable entry



Page 30

D Series

- Metal body
- 56 x 82 x 44mm body
- 72mm screw centres
- Heavy duty operation
- IP65
- 2 x M20 cable entry

IN65 Series

Double insulated robust limit switch

Standard sized robust plastic limit switch suitable for use on safety facilities and position monitoring in virtually any industrial application.

Thanks to their standard dimensions as well as the wide range of contacts and actuators, the IN65 switches can be used on safety facilities and for position monitoring in virtually any industrial application. Due to the metal actuator locking and mounting clip, the product is particularly robust. The IN65 ideally combines the economic advantages of a plastic-bodied switch with the sturdiness of a metal-bodied one.

Actuators		 SM	 RK	 HK	 DGHK	 DGKK
Contacts	Action	Top push – turret with standard metal plunger	Top push – turret with plastic roller plunger Ø10mm	Top push – turret with roller lever Ø11mm	Top push – turret with angled roller lever adjustable 6-12mm, Ø22mm	Top push – turret with angled roller lever adjustable 18-24mm, Ø22mm Nylon roller lever
1 NC / 1 NO	Snap	608-3000-207	608-3000-214	608-3000-221	608-3000-228	608-3000-254
	Slow	608-3000-208	608-3000-215	608-3000-222	608-3000-229	608-3000-255
2 NC*	Snap	608-3000-209	608-3000-216	608-3000-223	608-3000-230	608-3000-256
	Slow	608-3000-210	608-3000-217	608-3000-224	608-3000-231	608-3000-257
2 NO	Snap	608-3000-211	608-3000-218	608-3000-225	608-3000-232	608-3000-258
	Slow	608-3000-212	608-3000-219	608-3000-226	608-3000-233	608-3000-259
1 NC / 1 NO	Overlap	608-3000-213	608-3000-220	608-3000-227	608-3000-234	608-3000-260
Trade Price	Snap	\$42.51	\$48.06	\$46.21	\$48.06	\$48.06
	Slow	\$40.66	\$46.21	\$44.36	\$46.21	\$46.21
	Overlap	\$40.66	\$46.21	\$44.36	\$46.21	\$46.21

Actuators		 KNK	 AHK	 AHSGU RO50	 AHDM	 AVK
Contacts	Action	Action Top push – turret with roller lever angled Ø22x5mm	Side rotary – turret with lever arm & plastic roller	Side rotary – turret with lever arm & large roller Ø50mm	Side rotary – turret with adjustable rod 200mm long	Side rotary – turret with adjustable arm 16-51.5mm
1 NC / 1 NO	Snap	608-3000-261	608-3000-235	608-3000-300	608-3000-307	608-3000-280
	Slow	608-3000-262	608-3000-236	608-3000-296	608-3000-303	608-3000-284
2 NC*	Snap	608-3000-263	608-3000-237	608-3000-301	608-3000-308	608-3000-286
	Slow	608-3000-264	608-3000-238	608-3000-297	608-3000-304	608-3000-279
2 NO	Snap	608-3000-265	608-3000-239	608-3000-302	608-3000-309	608-3000-288
	Slow	608-3000-266	608-3000-240	608-3000-298	608-3000-305	608-3000-287
1 NC / 1 NO	Overlap	608-3000-267	608-3000-241	608-3000-299	608-3000-306	608-3000-285
Trade Price	Snap	\$44.37	\$51.75	\$59.14	\$55.45	\$53.61
	Slow	\$42.51	\$49.90	\$57.29	\$53.60	\$51.75
	Overlap	\$42.51	\$49.90	\$57.29	\$53.60	\$51.75

* suitable for use with safety relays to provide better than category 2

Guide element for top push switch 351-5900-209
 IN65 – allows for panel mounting **\$1.30**



Din rail mounting plate for IN65 359-5900-087
\$10.95



C2 Series

Insulation-enclosed miniature limit switch

Small switch body ideal for safety applications and position monitoring where space is critical.

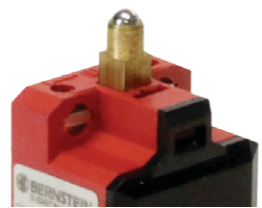
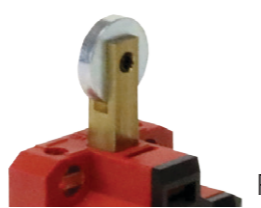
		Actuators	
		 W	 R
Contacts	Action	Top push –standard plunger metal Ø5mm	Top push – roller plunger metal Ø12x2.4mm
1 NC / 1 NO	Slow	600-8101-001 \$46.82	
	Snap	600-8351-002 \$49.21	
2 NC*	Snap		600-8866-016 \$68.27
2 NO	Slow		600-8816-017 \$64.37

* suitable for use with safety relays to provide better than category 2

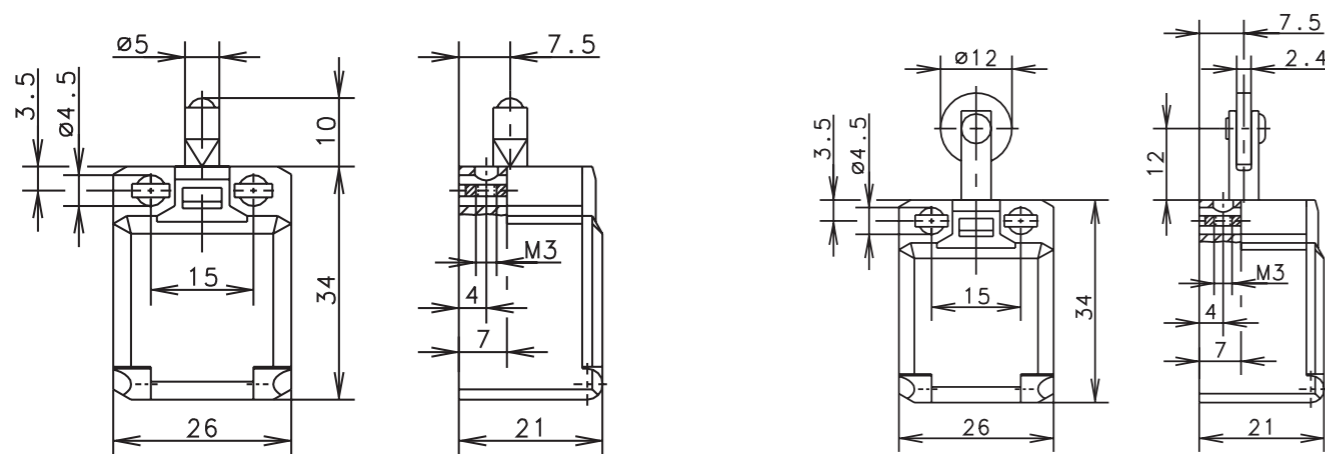

Advantages

- Miniature switch for safety applications
- Two-channel safety monitoring possible
- Captive snap-on cover
- Small hysteresis in snap action

Design Layout

- Slow-action and snap-action contacts
- Versions: 1 NC / 1 NO, 2 NC, 2 NO
- All NC contacts with \ominus in the circuit diagram are positively opening contacts
- Type: Zb (galvanically isolated changeover contact)

Mounting

- Suitable for front mounting (depending on type)
- a) 2 round holes for M4 screws
- b) 2 integrated nuts for front mounting for M3 screws (depending on type)

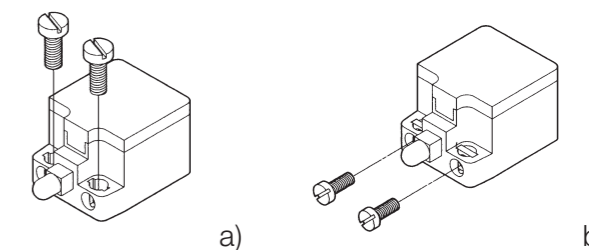

Installation Advantages

- Snap-on cover can be released with screwdriver
- Cover opening range 180° (cover can be detached from hinge)
- Cover protects switching element during installation
- Screw connections with self-lifting clamping plates
- Easy-action cover lock (close and press)

Technical Data





- Rated operating voltage U_e : 240 V
- Rated insulation voltage U_i : 240 V AC
- Conv. thermal current I_{the} : 10 A
- Utilisation category / switching capacity: AC-15, 240 V / 3 A
- Protection class: \square Class II
- Thermoplastic, glass fibre-reinforced (UL 94-V0) body
- Switching frequency max.: $\leq 100/\text{min.}$
- Mechanical service life (up to): 3×10^6 switching cycles
- Ambient temperature: -30°C to $+80^\circ\text{C}$
- Protection class: IP20 conforming to EN 60529
- Conductor size: single-wire $0.5 - 1.5\text{mm}^2$ or stranded wire with ferrule $0.5 - 1.5\text{mm}^2$
- Cable entry – rectangle $8.5 \times 3.5\text{mm}$

Ti2 Series

Double insulated compact limit switches

Body size: 45 (h) x 30 (w) x 27 (d) mm

Ideal for safety applications and position monitoring in confined spaces with protection class IP65

Actuators		 W	 RIW	 HW	 AH	 AD
Contacts	Action	Top push – standard plunger nylon Ø7mm	Top push – roller plunger nylon Ø10mm	Top push – roller lever nylon Ø13.5mm	Side rotary – turret with lever arm & roller	Side rotary – turret with adjustable rod 150mm long
1 NC / 1 NO	Slow		608-8117-007 \$72.68			
	Snap	608-8153-002 \$64.11	608-8167-008 \$82.37	608-8171-016 \$86.88	608-8185-022 \$106.36	608-8187-028 \$107.92
2 NC*	Snap	608-8853-004 \$75.51				

* suitable for use with safety relays to provide better than category 2

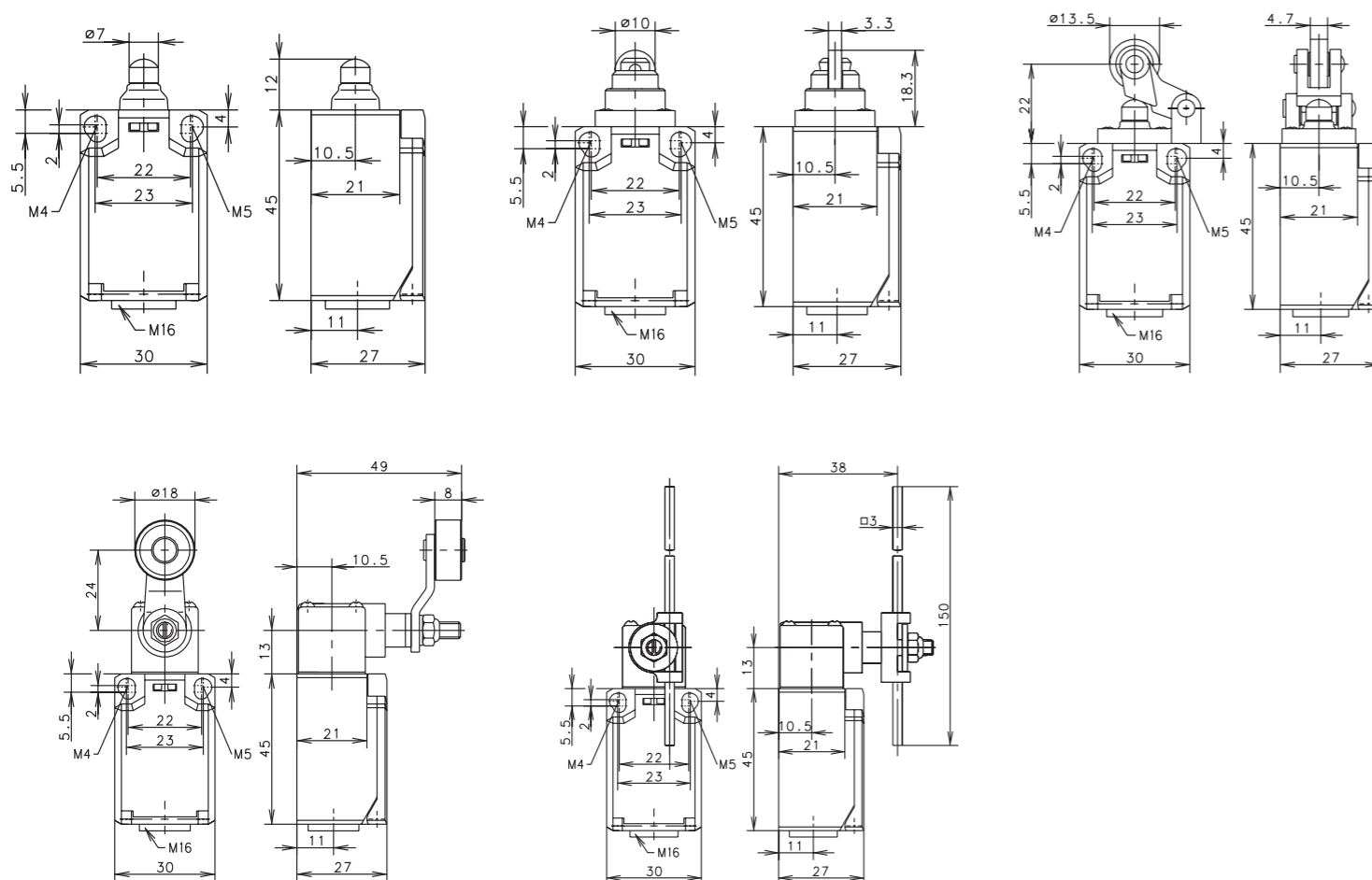

Advantages

- Compact switch for safety or control applications
- Two-channel safety monitoring possible
- Protection class IP65
- Captive snap-on cover
- Small hysteresis in snap action
- Actuator can be repositioned by 4 x 90°

Design Layout

- Slow-action and snap-action contacts
- Versions: 1 NC / 1 NO, 2 NC
- All NC contacts with ⊖ in the circuit diagram are positively opening contacts
- Type: Zb (galvanically isolated changeover contact)

Mounting

- Mounting dimensions conforming to DIN EN 50047
- 2 slots for adjustment with M4 screws (centres 22mm)
- Fixed positioning for safety applications with two M5 screws (centres 23mm)

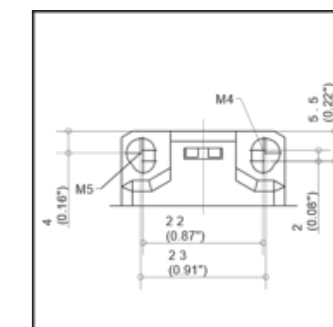

Installation Advantages

- Snap-on cover can be released with screwdriver
- Cover protects switching element during installation
- Screw connections with self-limiting clamping plates
- Easy-action cover lock (close and press)

Technical Data

- Rated operating voltage U_e : 240 V
- Rated insulation voltage U_i : 240 V AC
- Conv. thermal current I_{the} : 10 A
- Utilisation category / switching capacity: AC-15, 240 V / 3 A; DC-13, 240V / 0.27A
- Protection class: \square Class II
- Switching frequency max.: $\leq 100/\text{min.}$
- Mechanical service life (up to): 3×10^6 switching cycles
- Ambient temperature: -30°C to + 80°C
- Protection class: IP65 conforming to EN 60529
- Conductor size: single-wire 0.5 – 1.5mm² or stranded wire with ferrule 0.5 – 1.5mm²
- Cable entry – 1 x M16 x 1.5





I88 Series

Double insulated limit switch



Body size: 62 (h) x 31 (w) x 30.5 (d) mm

Standard sized plastic limit switch suitable for use on safety and position monitoring in virtually any industrial application.

To be phased out and replaced by the IN65 Series

Actuators		 IW	 RIWK	 RIWL	 HW RO11	 KNW RO22
Contacts	Action	Top push – standard plunger nylon Ø8mm	Top push – turret with nylon roller plunger Ø10mm	Top push – turret with roller plunger Ø14mm	Top push – roller lever nylon Ø11mm	Top push – roller lever angled Ø22x5mm
1 NC / 1 NO	Slow	608-6103-008 \$55.04				
	Snap		608-6167-018 \$68.40	608-6167-051 \$71.24	608-6171-022 \$76.24	608-6177-053 \$78.64
2 NC / 1 NO*	Slow				608-6521-103 \$83.07	

* suitable for use with safety relays to provide better than category 2

Actuators		 AH	 AV	 FF
Contacts	Action	Side rotary – turret with lever arm & roller	Side rotary – turret with adjustable arm 19.5-55mm	Top actuate – wobble stick 135mm long
1 NC / 1 NO	Slow		608-6136-037 \$102.25	
	Snap	608-6185-034 \$96.20		608-6190-078 \$101.50

Guide element for top push switch I88 – allows for panel mounting 351-5900-209
\$1.30



Din rail mounting plate for I88 359-5900-087
\$10.95



I88 Series

Dimensions



IW

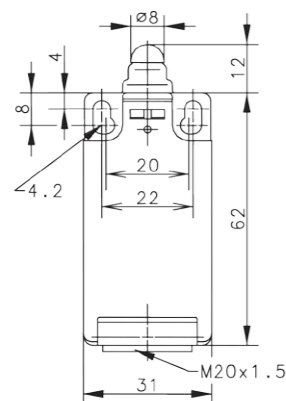

RIWK

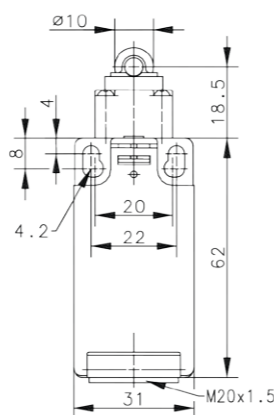

RIWL

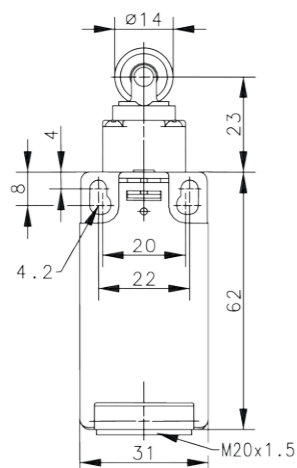

HW RO11

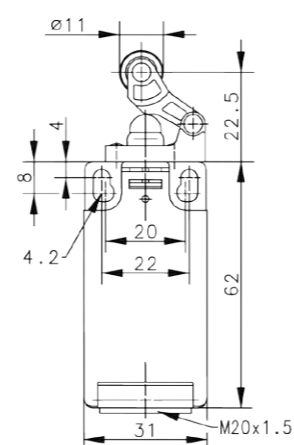

KNW
RO22

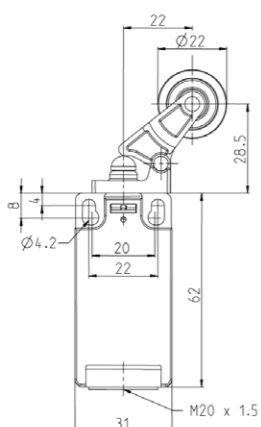

AH

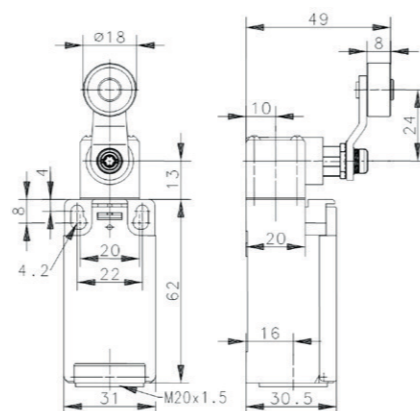

AV

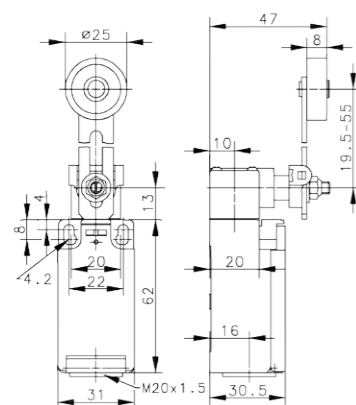

FF

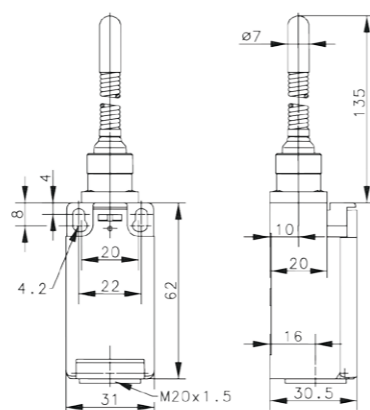

Advantages

- Standard switch conforming to DIN EN 50047
- Standard actuator conforming to DIN EN 50047
- Enclosure and cover PA 6, self-extinguishing (UL-94-V0)
- Protection class to IP65 to VDE 0470 T1
- Actuator can be repositioned by 4 x 90°
- Captive snap-on cover
- Cable entry M20 x 1.5

Design Layout

- Slow-action and snap-action contacts
- Versions: 1 NC / 1 NO, 2 NC / 1 NO
- All NC contacts with ⊖ in the circuit diagram are positively opening contacts
- Type: Zb (galvanically isolated changeover contact)

Mounting

- Two M4 screws, adjustment with slots (22mm centres)
- Two M5 screws for safety applications without additional fixing element (20mm centres)
- Optionally secured onto DIN rail by guide plate for lateral approach forces
- Optional front mounting, depending on type



Installation Advantages

- Snap-on cover can be released with a screwdriver
- Cover opening range 135° (cover can be detached from hinge)
- Cover protects switching element during installation
- Screw connections with self-lifting clamping plates
- Easy-action cover lock (close and press)
- Cover additionally secured with screw

Technical Data



- Rated operating voltage U_e : 240 V
- Rated insulation voltage U_i : 250 V AC
- Conv. thermal current I_{the} : 10 A
- Utilisation category / switching capacity: AC-15, 240 V / 3 A
- Protection class: □ Class II
- Thermoplastic, glass fibre-reinforced (UL 94-V0) body and cover
- Switching frequency max.: ≤ 100/min.
- Mechanical service life (up to): 10 x 10⁶ switching cycles
- Ambient temperature: -30°C to + 80°C
- Conductor size: single-wire 0.5 – 1.5mm² or stranded wire with ferrule 0.5 – 1.5mm²
- Protection type: IP65 conforming to EN 60529
- Cable entry – 1 x M20 x 1.5

ENK Series



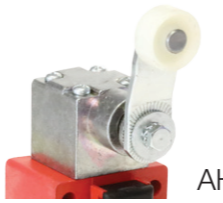
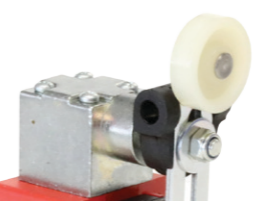
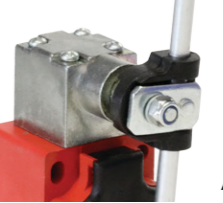

Insulation-enclosed limit switch with metal actuators.

Body size: 73.5 (h) x 40 (w) x 40 (d) mm

Due to its design and metal actuator, the ENK limit switch is particularly suitable for applications requiring a sturdy switch made of plastic.

Actuators		 IW	 RIW	 AHS-V	 AV	 AD
Contacts	Action	Top push – standard plunger metal Ø10mm	Top push – roller plunger metal Ø18mm	Side rotary – turret with lever arm & roller	Side rotary – turret with adjustable arm 27-81mm	Side rotary – turret with adjustable rod 200mm
1 NC / 1 NO	Snap	608-1152-007 \$78.03	608-1167-008 \$88.57	608-1185-009 \$110.36	608-1186-018 \$129.77	608-1187-017 \$123.77
2 NC*	Slow			608-1835-323 \$180.37		

* suitable for use with safety relays to provide better than category 2

Actuators		 HW RO20	 FF	 AHS-V 270GR	 IW RAST
Contacts	Action	Top push – roller lever nylon Ø20mm	Top actuate – wobble stock 133mm long	Top push – turret with lever arm and roller Ø14mm	Top push – standard plunger metal Ø10mm with reset
1 NC / 1 NO	Slow				618-1102-137# \$135.37
	Snap	608-1171-096 \$98.22	608-1190-045 \$118.03		
	Overlap Slow			618-1335-150% \$311.48	

discontinued, only while stock lasts % special indent – check for stock

Operating diagram

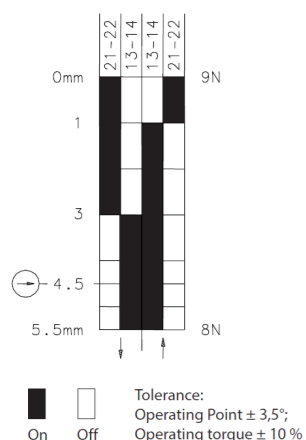

1 NC / 1 NO

snap action example of contact operation and symbol

Operating symbol

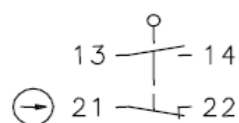

1 NC / 1 NO

overlap slow action example of contact operation and symbol

Operating symbol

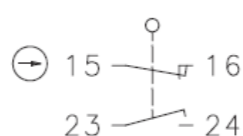

Operating diagram

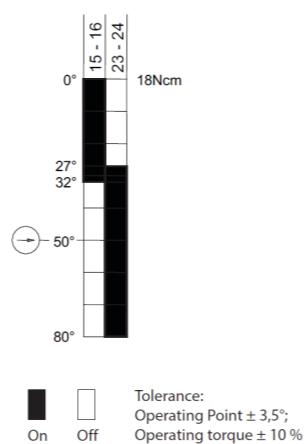

Operating diagram

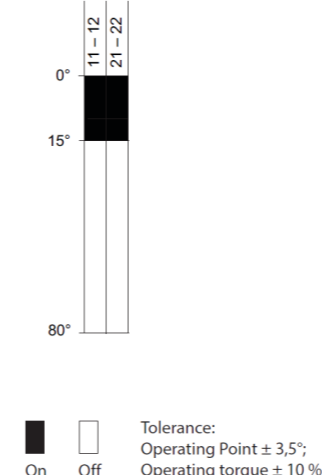

2 NC slow action example of contact operation and symbol

Operating symbol

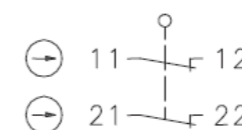

ENK Series

Dimensions



IW

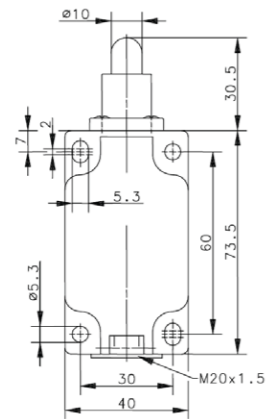

RIW

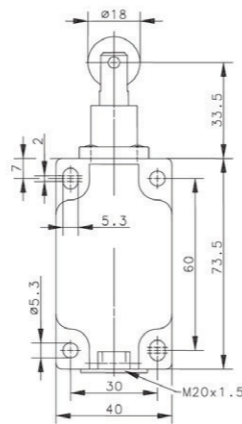

AHS-V

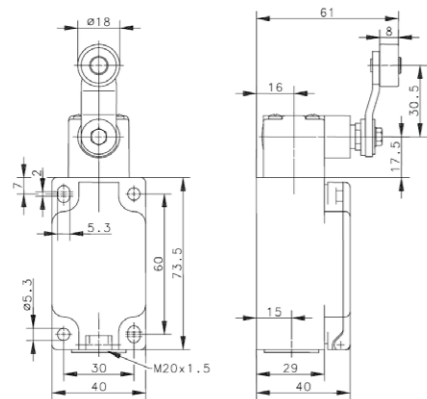

AV

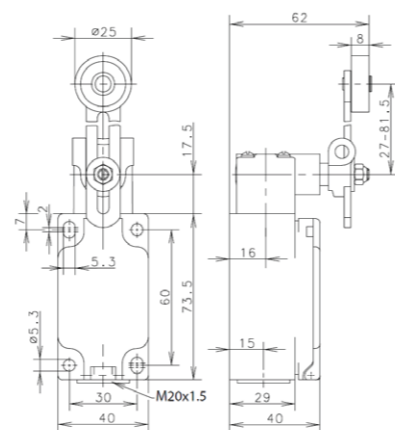

AHS-V
270GR



AD

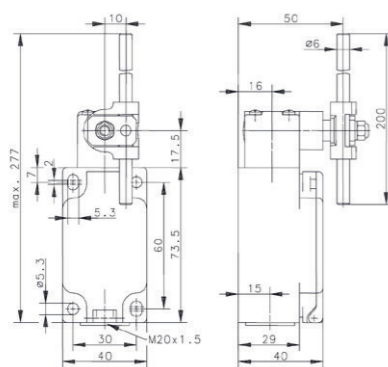

HW RO20

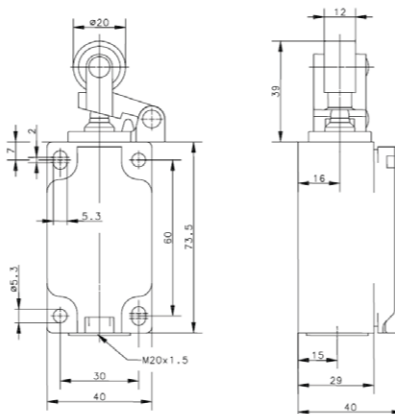

FF

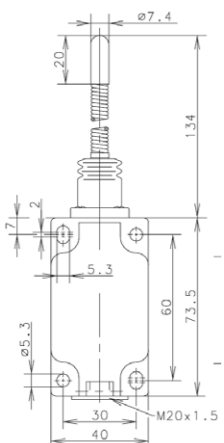

RAST

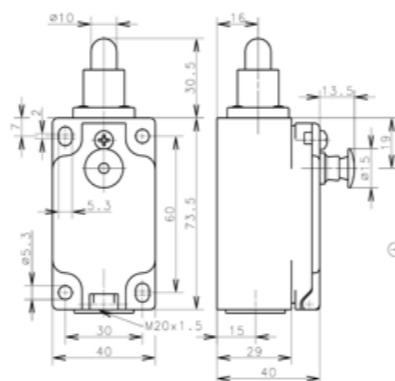

Advantages

- Metal actuator for high loads
- Standard switch conforming to DIN EN 50041
- Standard actuator conforming to DIN EN 50041
- Enclosure and cover PA 6, self-extinguishing (UL-94-V0)
- Protection class to IP65 to VDE 0470 T1
- Actuator can be repositioned by 4 x 90°
- Captive snap-on cover
- Cable entry M20 x 1.5

Design Layout

- Slow-action and snap-action contacts
- Versions: 1 NC / 1 NO, 2 NC
- All NC contacts with \ominus in the circuit diagram are positively opening contacts
- Type: Zb (galvanically isolated changeover contact)

Mounting

- Two M5 screws, adjustment with slots (30mm centres)
- Two M5 screws for safety applications without additional fixing element (30mm centres)

Installation Advantages

- Snap-on cover can be released with screwdriver
- Cover opening range 150° (cover can be detached from hinge)
- Cover protects switching element during installation
- Screw connections with self-lifting clamping plates
- Easy-action cover lock (close and press)

Technical Data





- Rated operating voltage U_e : 240 V
- Rated insulation voltage U_i : 400 V AC
- Conv. thermal current I_{the} : 10 A
- Utilisation category / switching capacity: AC-15, 240 V / 3 A
- Protection class: \square Class II
- Thermoplastic, glass fibre-reinforced (UL 94-V0) body and cover
- Switching frequency max.: $\leq 100/\text{min.}$
- Mechanical service life (up to): 10×10^6 switching cycles
- Ambient temperature: -30°C to + 80°C
- Conductor size: single-wire 0.5 – 1.5mm² or stranded wire with ferrule 0.5 – 1.5mm²
- Protection type: IP65 conforming to EN 60529
- Cable entry – 1 x M20 x 1.5

GC Series





Compact metal limit switch



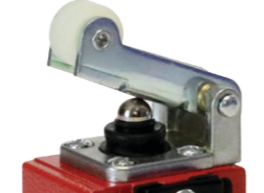

Body size: 72 (h) x 36 (w) x 32.5 (d) mm

Thanks to its compact design, this metal-enclosed switch is ideally suited to virtually all safety and position monitoring situations.

Actuators	 IW	 W	 STIW	 RIW	 HW	
Contacts	Action	Top push – standard plunger inner seal metal Ø5mm	Top push - standard plunger outer seal plastic Ø7mm	Top push – adjustable plunger metal Ø5mm	Top push - roller plunger metal Ø14mm	Top push - roller lever outer seal nylon Ø13mm
1 NC / 1 NO	Slow	602-1102-001 \$94.63	602-1103-008 \$99.75	602-1105-015 \$100.33	602-1117-029 \$105.60	602-1121-067 \$120.55
2 NC / 1 NO*	Slow				602-2517-032 \$162.70	

* suitable for use with safety relays to provide better than category 2

Actuators	 HIW	 HLW	 KU	 KNIW	 AD	
Contacts	Action	Top push – roller lever inner seal nylon Ø13mm	Top push – roller long lever nylon Ø13mm	Top push - ball plunger metal Ø12mm	Top push – angled roller lever Ø13mm	TSide rotary – turret with adjustable rod 200mm long
1 NC / 1 NO	Slow					602-1137-103 \$159.45
	Snap	602-1370-629 \$127.63	602-1374-632 \$126.10	602-1160-052 \$128.30	602-1176-073 \$119.48	

Actuators	 AV	 AH	 AF	 FF	
Contacts	Action	Side rotary – turret with adjustable arm 27-81.5mm long	Side rotary – turret with lever arm and roller	Side rotary – turret with wobble stick 144mm long	Top actuate – wobble stick 133mm long
1 NC / 1 NO	Slow	602-1136-104 \$175.78	602-1135-102 \$159.45	602-1139-106 \$159.45	602-1140-476 \$151.70

Advantages

- Metal actuator for high loads
- Protection class IP65 to VDE 0470 T1
- Enclosure, aluminium pressure die-casting
- Cover, sheet aluminium
- Actuator can be repositioned by 4 x 90°
- Cable entry 1 x M20 x 1.5

Design Layout





- Slow-action and snap-action contacts
- Versions: 1 NC / 1 NO, 2 NC / 1 NO,
- All NC contacts with ⊖ in the circuit diagram are positively opening contacts
- Type: Zb (galvanically isolated changeover contact)

ENM2 Series

Standard sized metal body and actuator limit switch

Body size: 77.5 (h) x 40 (w) x 42 (d) mm

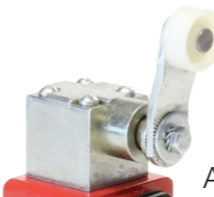
With its standard enclosure, the ENM2 limit switch can be used universally in all industrial and safety applications.

Actuators		 IW	 RIW	 AHS-V	 DGHW RO20	 DGKW RO20
Contacts	Action	Top push – standard plunger metal Ø10mm	Top push – roller plunger metal Ø18mm	Side rotary – turret with lever arm and nylon roller Ø18mm	Top push – adjustable roller lever nylon Ø20mm	Top push – adjustable roller cranked lever Ø20mm
1 NC / 1 NO	Slow	608-7102-001 \$93.50		608-7135-013 \$114.60		
	Snap	608-7352-002 \$99.20	608-7367-005 \$108.23	608-7385-014 \$119.15	608-7371-008 \$116.55	608-7377-011 \$116.55
2 NC*	Slow		608-7817-006 \$122.19	608-7835-015 \$134.52	608-7821-009 \$131.65	

* suitable for use with safety relays to provide better than category 2

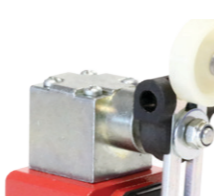
Actuators		 AD	 AV
Contacts	Action	Side rotary – Turret with adjustable rod 200mm long	Side rotary – turret with adjustable arm 27-81.5mm
1 NC / 1 NO	Slow	608-7137-018 \$124.45	608-7136-016 \$126.65
	Snap	608-7387-019 \$134.55	608-7386-017 \$135.38

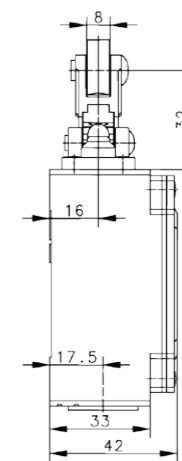
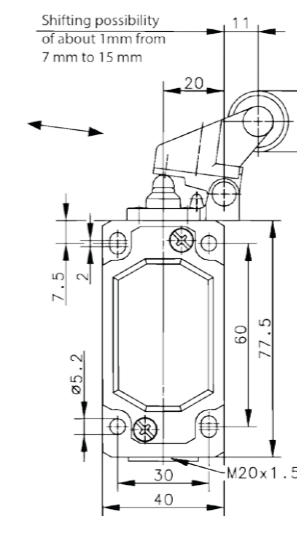
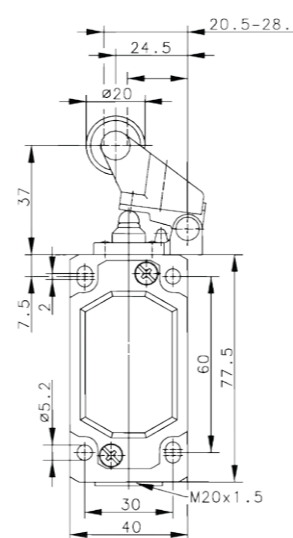
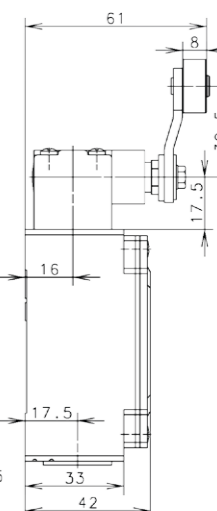
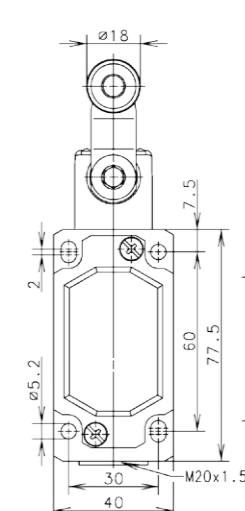
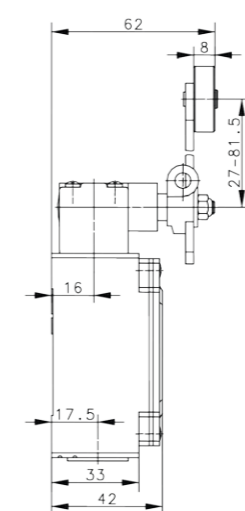
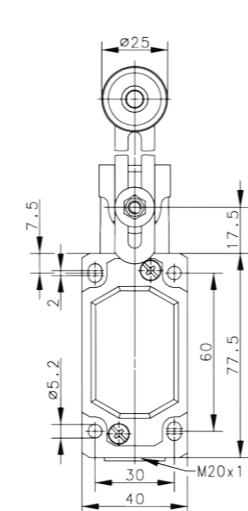
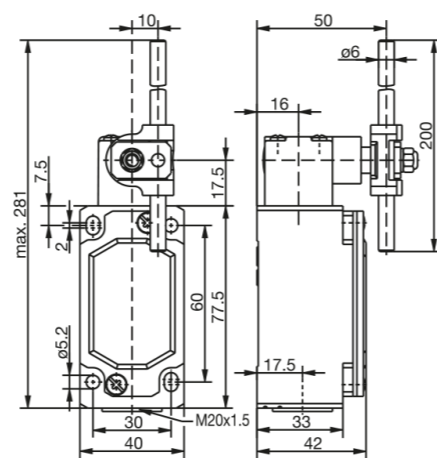
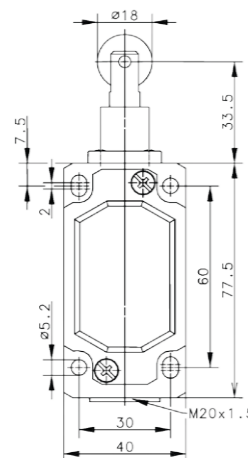
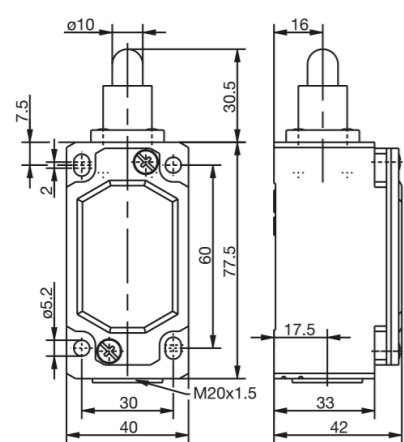

ENM2 Series

Advantages

- Metal actuator for high loads
- Standard switch conforming to DIN EN 50041
- Standard actuator conforming to DIN EN 50041
- Enclosure: Aluminium pressure die-casting
- Cover: Sheet aluminium
- Protection class to IP65 to VDE 0470 T1
- Actuator can be repositioned by 4 x 90°
- Cable entry M20 x 1.5

Design Layout

- Slow-action and snap-action contacts
- Versions: 1 NC / 1 NO, 2 NC
- All NC contacts with \ominus in the circuit diagram are positively opening contacts
- Type: Zb (galvanically isolated changeover contact)

Mounting

- Two M5 screws, adjustment with slots (30mm centres)
- Two M5 screws for safety applications without additional fixing element (30mm centres)

Installation Advantages

- Screw connections with self-lifting clamping plates
- Captive cover screws
- Easy-to-change switching system thanks to snap-in retainer (depending on type)

Technical Data

- Rated operating voltage U_e : 240 V
- Rated insulation voltage U_i : 400 V AC
- Conv. thermal current I_{the} : 10 A
- Utilisation category / switching capacity: AC-15, 240 V / 3 A
- Protection class: Class I
- Aluminium pressure die-casting body
- Switching frequency max.: ≤ 100 /min.
- Mechanical service life (up to): 10×10^6 switching cycles
- Ambient temperature: -30°C to + 80°C
- Conductor size: single-wire 0.5 – 1.5mm² or stranded wire with ferrule 0.5 – 1.5mm²
- Protection type: IP65 conforming to EN 60529
- Cable entry – 1 x M20 x 1.5

SN2 Series

Spacious metal enclosed limit switch

With its three cable entries and spacious connection area, the SN2 limit switch is the optimised solution for through-wiring or even branching off electrical circuits.

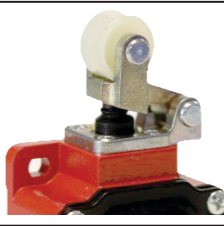
	Actuators	
Contacts	Action	Top push – roller lever nylon Ø20mm
1 NC / 1 NO	Snap	603-3371-006 \$141.90

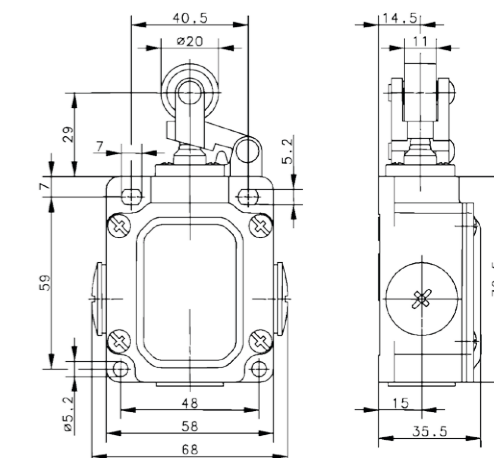

Advantages

- Metal actuator for high loads
- Enclosure: Aluminium pressure die-casting
- Cover: Sheet aluminium
- Protection class to IP65 to VDE 0470 T1
- Actuator can be repositioned by 4 x 90°
- Cable entry 3 x M20 x 1.5

Design Layout

- Snap-action contacts
- Versions: 1 NC / 1 NO
- All NC contacts with \ominus in the circuit diagram are positively opening contacts
- Type: Zb (galvanically isolated changeover contact)

Mounting

- Two M5 screws, adjustment with slots (40.5mm centres)
- Two M5 screws for safety applications without additional fixing element (48mm centres)

Installation Advantages

- 3 cable entries for through-wiring
- Generously dimensioned connection space
- Screw connections with self-lifting clamping plates
- Easy-to-change switching system thanks to snap-in retainer (depending on type)

Technical Data





- Rated operating voltage U_e : 240 V
- Rated insulation voltage U_i : 400 V AC
- Conv. thermal current I_{the} : 10 A
- Utilisation category / switching capacity: AC-15, 240 V / 3 A
- Protection class: Class I
- Aluminium pressure die-casting body
- Switching frequency max.: ≤ 100 /min.
- Mechanical service life (up to): 10×10^6 switching cycles
- Ambient temperature: -30°C to + 80°C
- Conductor size: single-wire 0.5 – 1.5mm² or stranded wire with ferrule 0.5 – 1.5mm²
- Protection type: IP65 conforming to EN 60529
- Cable entry – 3 x M20 x 1.5

D Series

Heavy duty metal enclosed limit switch

Body size: 56 (h) x 82 (w) x 44 (d) mm

Thanks to its heavy-duty body with particularly tough design of actuator and switching systems, the switch type D is ideally suited for harsh operating conditions.

Actuators		 W	 RW	 AH	 HW
Contacts	Action	Top push – standard plunger metal Ø11mm	Top push – roller plunger metal Ø20mm	Side rotary – turret with lever arm and metal roller Ø20mm	Top push – roller lever nylon Ø22mm
1 NC / 1 NO	Slow	614-1103-741 \$187.32	604-1118-008 \$185.10		604-1121-010 \$210.09
	Snap		604-1168-162 \$223.41	604-1185-173 \$295.83	

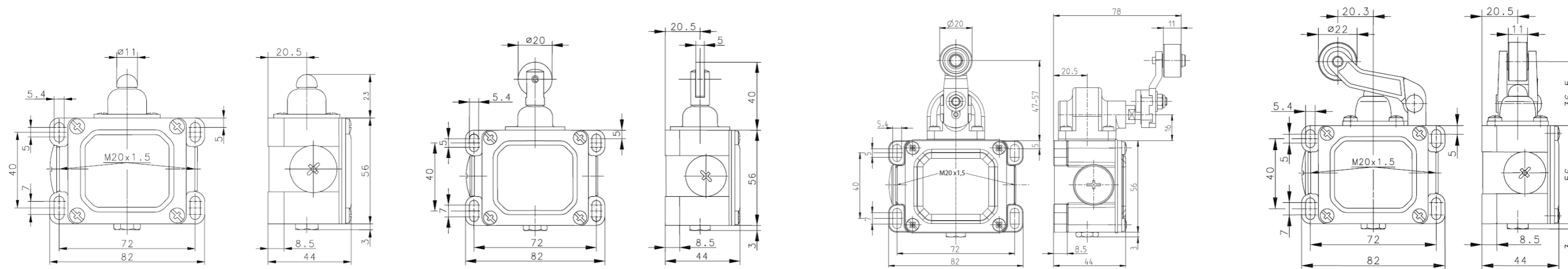

Advantages

- Metal actuator for high loads
- Hard wearing guide bushes
- Sturdy contacts
- Enclosure: Aluminium pressure die-casting
- Cover: Sheet aluminium
- Protection class to IP65 to VDE 0470 T1
- Actuator can be repositioned by 4 x 90°
- Cable entry 2 x M20 x 1.5

Design Layout

- Slow-action and snap-action contacts
- Versions: 1 NC / 1 NO
- All NC contacts with \ominus in the circuit diagram are positively opening contacts

Mounting

- Four M5 screws, adjustment with slots (72mm centres)

Installation Advantages

- 2 cable entries for through-wiring
- Generously dimensioned connection space
- Captive cover screws

Technical Data

- Rated operating voltage U_g : 240 V
- Rated insulation voltage U_i : 400 V AC
- Conv. thermal current I_{the} : 10 A
- Utilisation category / switching capacity: AC-15, 240 V / 3 A
- Protection class: Class I
- Aluminium pressure die-casting body
- Switching frequency max.: $\leq 100/\text{min.}$
- Mechanical service life (up to): 10×10^6 switching cycles
- Ambient temperature: -30°C to + 80°C
- Conductor size: single-wire 0.5 – 1.5mm² or stranded wire with ferrule 0.5 – 1.5mm²
- Protection type: IP65 conforming to EN 60529
- Cable entry – 2 x M20 x 1.5

Safety Relays

Safety Evaluation Devices (SCR), commonly referred to as Safety Relays, are used to evaluate signals, such as those generated by position switches, safety switches, safety latching devices, safety rope pull switches, safety sensors or 2-hand controllers. This means that in the event of a hazard, a safety relay will work to reduce risk to an acceptable level.

Some functions of safety relays include:

- Stopping a movement in a controlled and safe manner
- Monitoring the position of moving guards
- Interrupting a closing movement during access
- Emergency stop / off

Two positive opening normally-closed contacts are usually required as the signalling contacts for safety gate monitors. Virtually all Bernstein switches feature these contacts. They can be identified by the \ominus symbol.

Bernstein has a range of safety relays that can provide:

- One and two (dual) channel inputs
- Automatic / pushbutton start
- Redundant paths
- Monitored start

With these features a safety system can be configured for:

- Contact welding detection
- Disconnected switch recognition
- Redundant notification / signalling
- Feedback circuitry for additional redundancy



Part No.	Performance level (up to)	Enable current paths (NO contact)	Signalling contacts (NC contact)	Monitored start	Start automatic/pushbutton (manual)	Remarks
607-5111-009	e (≈cat. 4)	3	1	No	Auto / pushbutton	
607-5111-010	e (≈cat. 4)	3	1	Yes	Pushbutton	
607-5111-015	d (≈cat. 3)	2	0	No	Auto / pushbutton	
607-5111-016	d (≈cat. 3)	2	0	No	Pushbutton	
607-5111-018	e (≈cat. 4)	2	1	-	-	SCT for two handed controller

Electrical Importing Company Limited
117A Captain Springs Road, Onehunga
PO Box 13 872, Auckland 1643, New Zealand
www.eicnz.com

Phone: (09) 634 2978
Fax: (09) 634 6819
Email: eic@eicnz.com